



(GB) Assembly instructions

(PL) Instrukcja montażu

(DE) Montageanleitung

(CZ) Montážní návod

(FR) Notice de montage

(SK) Návod na montáž

(NL) Handleiding voor de montage

(HR) Montaže

(IT) Istruzioni di montaggio

(TR) Montaj talimat

(HU) Szerelési útmutató

(RO) Instrucțiuni de montaj

(ES) Instrucciones de montaje

(RU) Инструкции по монтажу

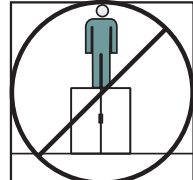
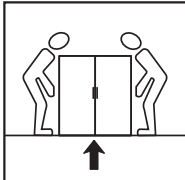
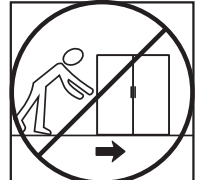
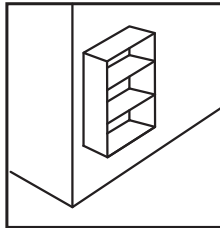
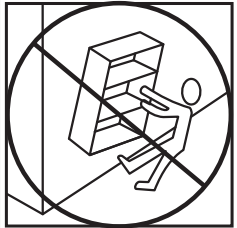
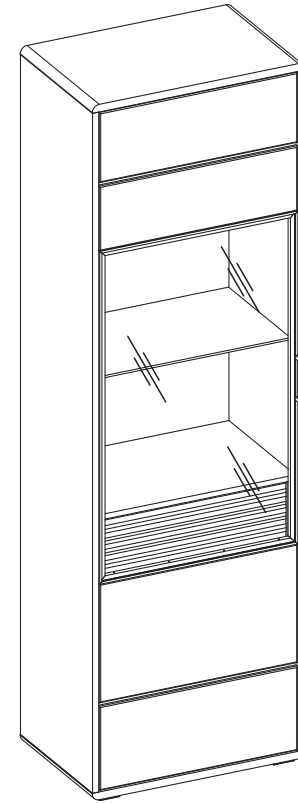

Mo	Tu	We	Th	Fr	Sa	Su
		1	2	3	4	5
6	7	8	9	10	11	12
13	14	15	16	17	18	19
20	21	22	23	24	25	26
27	28	29	30	31		

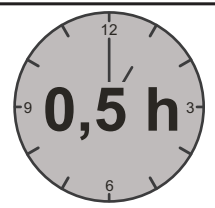
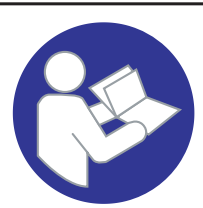
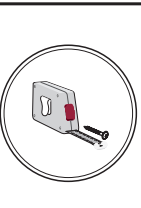
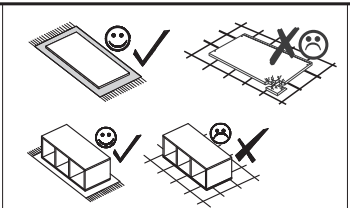
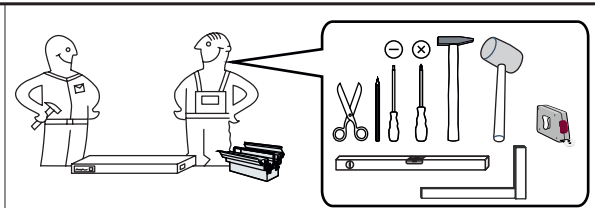
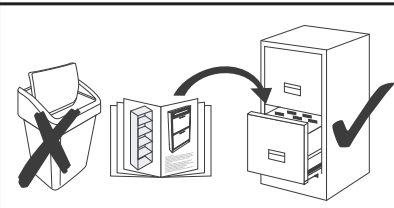

## Service • Assistenza • Dienstverlening • Serwis Servis • Szerviz • Servizio • Usluga • Нíđáčńír' Ñëóáčár

Name • Nom • Nome • Naam • Nazwa Jméno • Názov • Név • Denumire Nombre • Ime • Isim • Írçarıđı	<b>BELLIS</b>
Nr. • No. • N° • řířěđ • Ć • Sz • Ne	<b>SIMD34..</b>
Typ • Type • Tip • Típus • Tipo • Ńđđ	<b>10</b>

shop • geschäft • boutique • sklep • winkel • řřřřđı  
negozio • bolt • tienda • obchod • dućan • mađaza • magazin

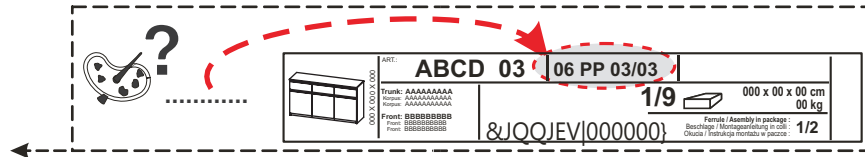
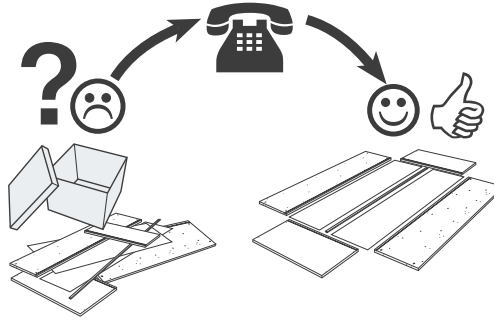

<b>T1</b> X...	<b>Z1</b> fi 35 KR15 X...	<b>T16</b> M6 X...	<b>K1</b> L-50 mm X...
<b>M1</b> X...	<b>Z1s</b> fi 35 KR15 X...	<b>M4</b> X...	<b>E6</b> 6x9,5 X...
<b>B1</b> fi 8x28 X...	<b>D19</b> H2 X...	<b>S17</b> 3,5x20 X...	<b>F51</b> L-350 mm X...
<b>B26</b> fi 8x32 X...	<b>S9</b> 4x16 X...	<b>L1</b> X...	<b>P10</b> 3x13 X...
<b>S11</b> 4x25 X...	<b>W10</b> X...	<b>S4</b> 3x16 X...	<b>R38</b> Quadro L 350 X...
<b>P6</b> 4x35 X...			

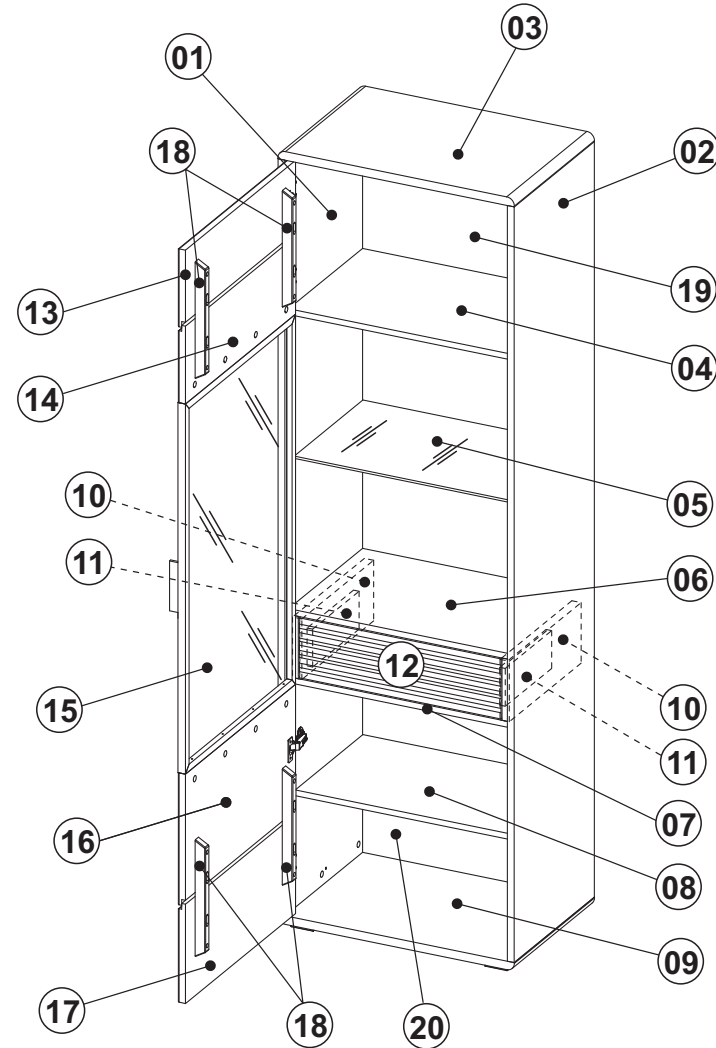

- max. 04  
06  
08
- max. 12
- max. 05





**1**

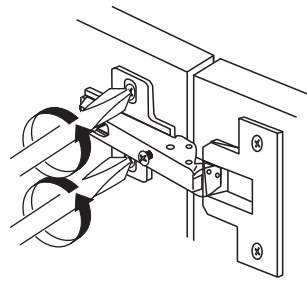
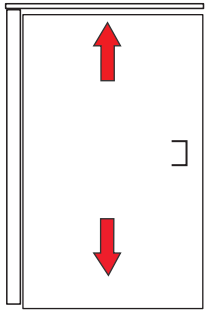

**2**

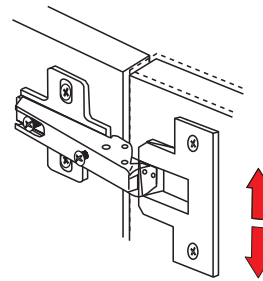

**3**

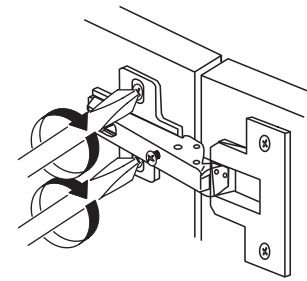

**1**

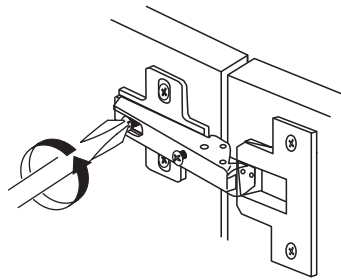
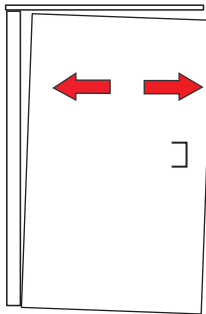

**2**

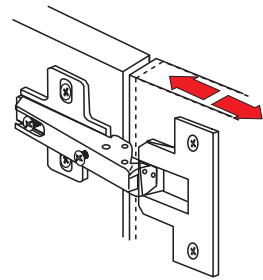

**3**

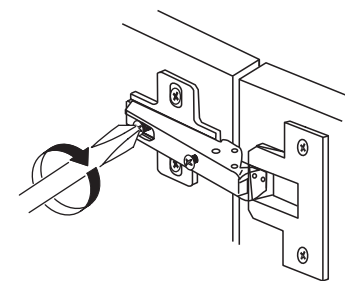

**1**

