

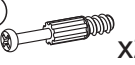









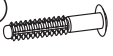









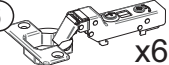

- B1**   $\phi$  8x28 x24
- T1**  x20
- M1**  x16
- C2**   $\phi$  20 x18
- B4**  x8
- M12**  x4
- P2**  3x16 x18
- J23**  x18
- F15**  x4
- F7**  x2
- S3**  3,5x13 x2
- J20**  x1
- U41**  x6
- A14**  M4x22 x6

- X6**  x6
- S9**  4x16 x12
- D9**  x6
- X19**  x2
- L21**  x4
- P13**  3,5x13 x16
- R37**  x2
- E1**  6,3x13 x8
- P2**  3x16 x4
- J11**  x1
- P13**  3,5x13 x2

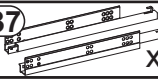

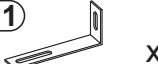
Nr	Ausmaß			St	Colli
1	1934	590	35	1	2
2	1934	590	35	1	2
3	350	100	12	2	1
4	350	100	12	2	1
5	886	189	15	2	1
6	479	50	15	4	2
7	852	100	12	2	1
8	894	544	15	3	1
9	990	604	22	1	1
12	1934	50	16	2	2
13	1446	442	16	2	2
16	892	50	16	1	1
17	863	349	2	2	1
18	1851	453	2	2	2

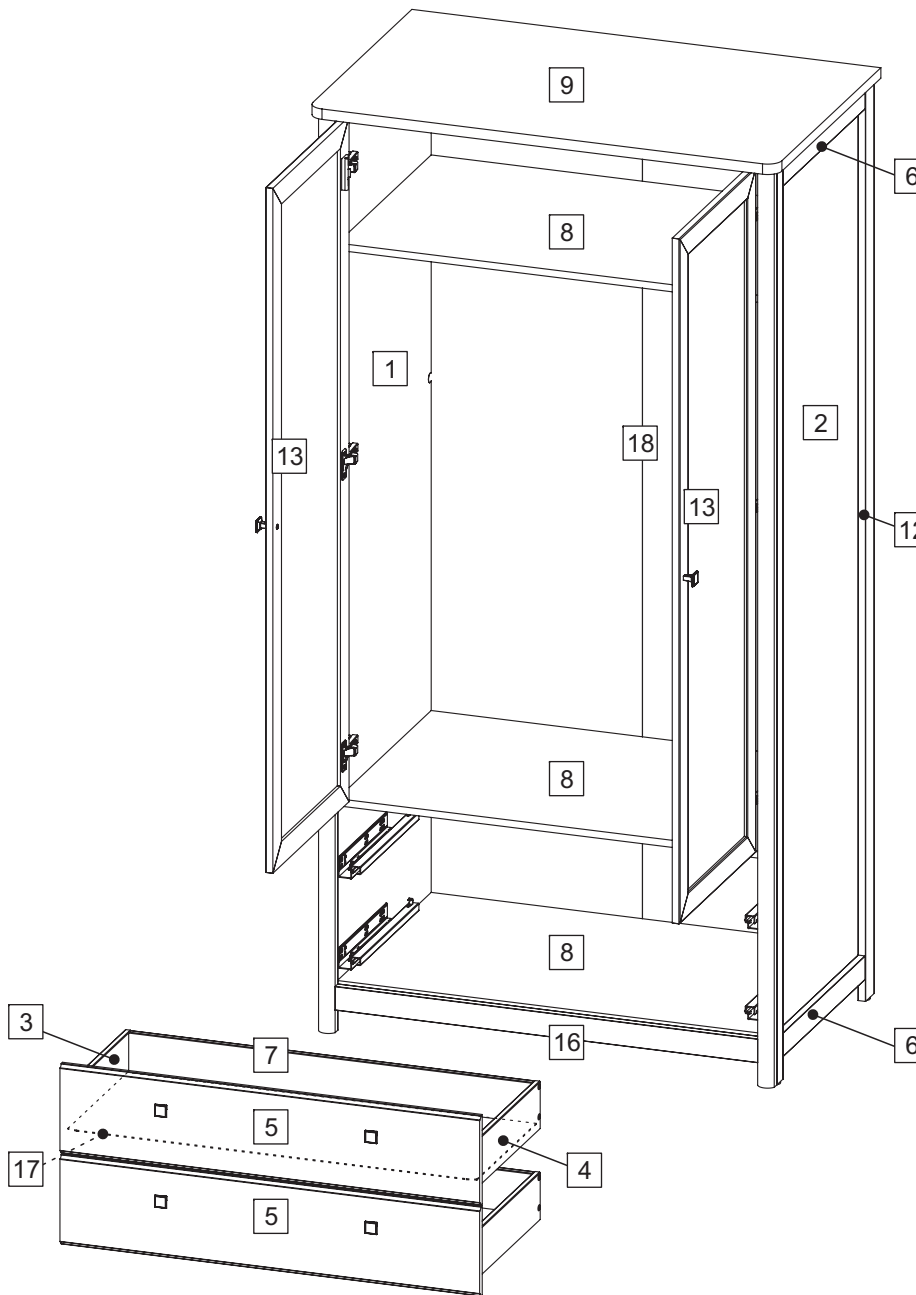
0 10 20 30 40 50 60 70 80 90 100 110 120 130 140 150 160 170 180 190 200



1

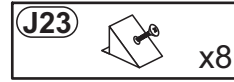
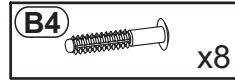
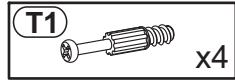
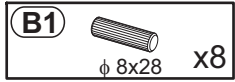

**A**

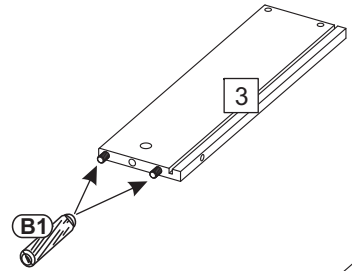
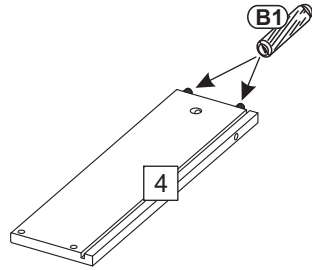

x2

**B**

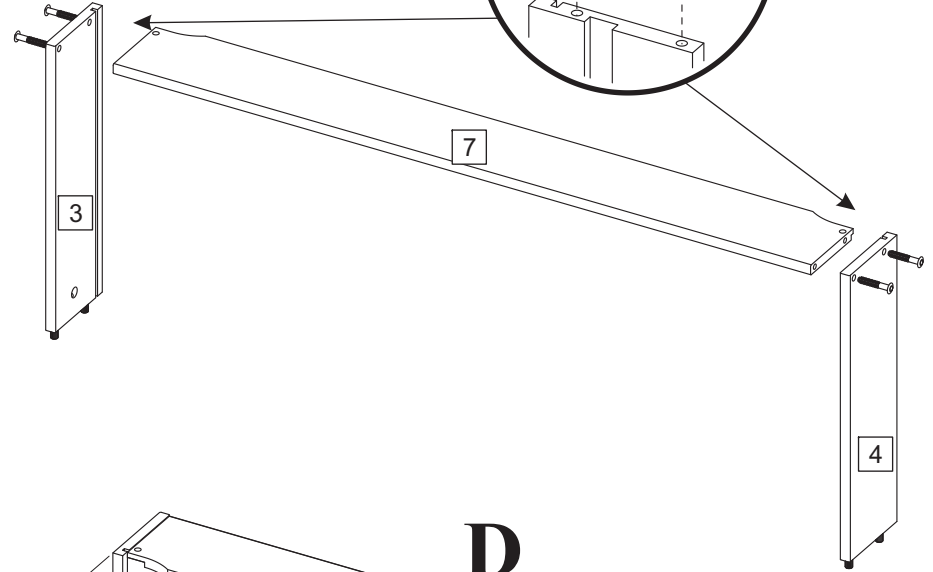
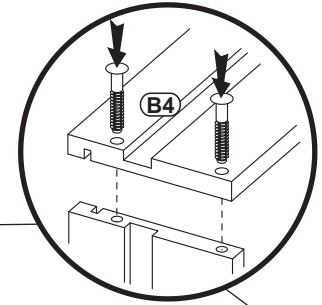

**C**

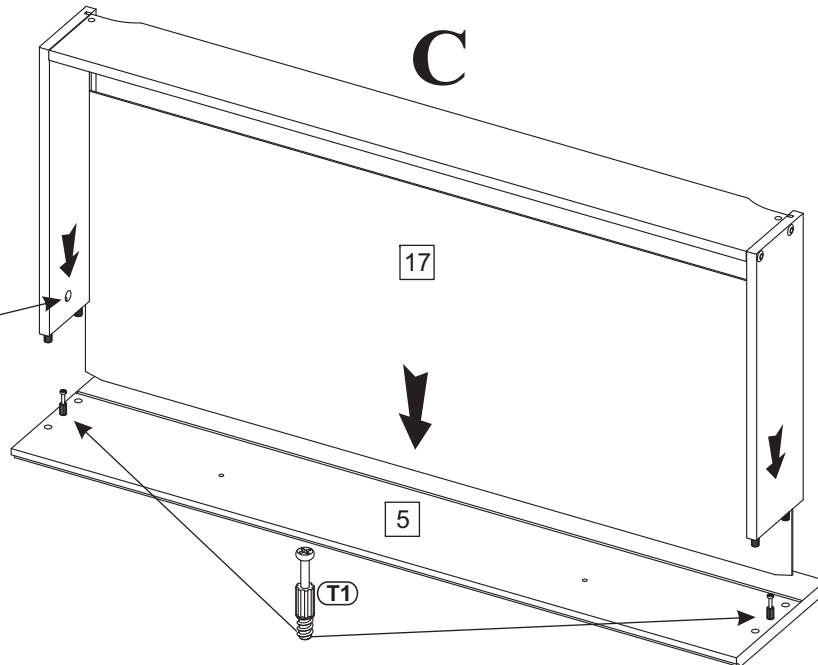
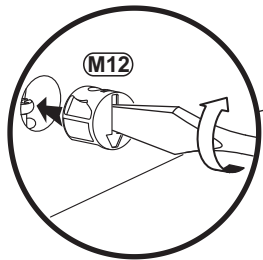

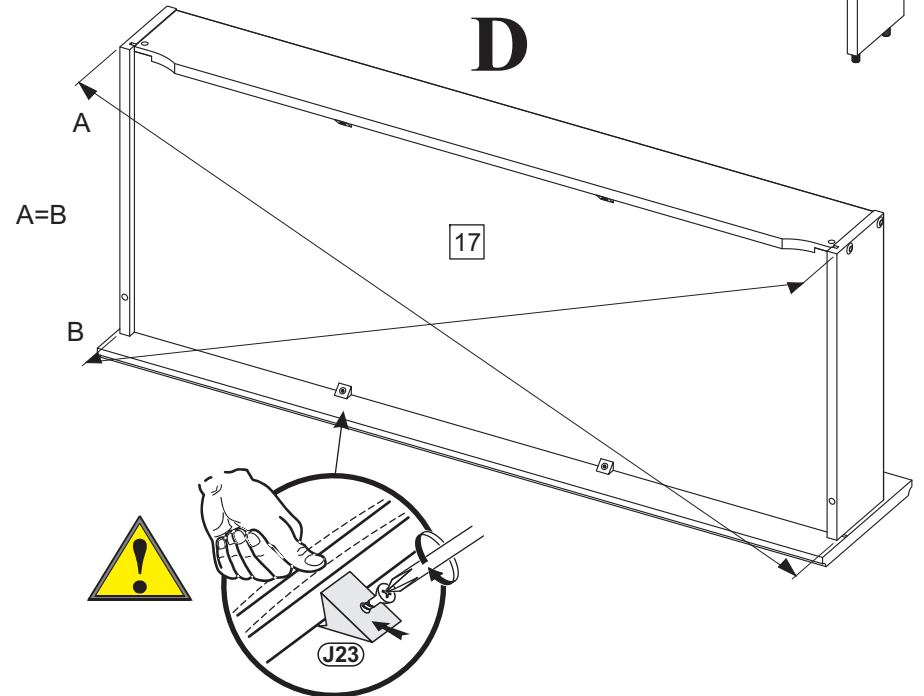

**D**

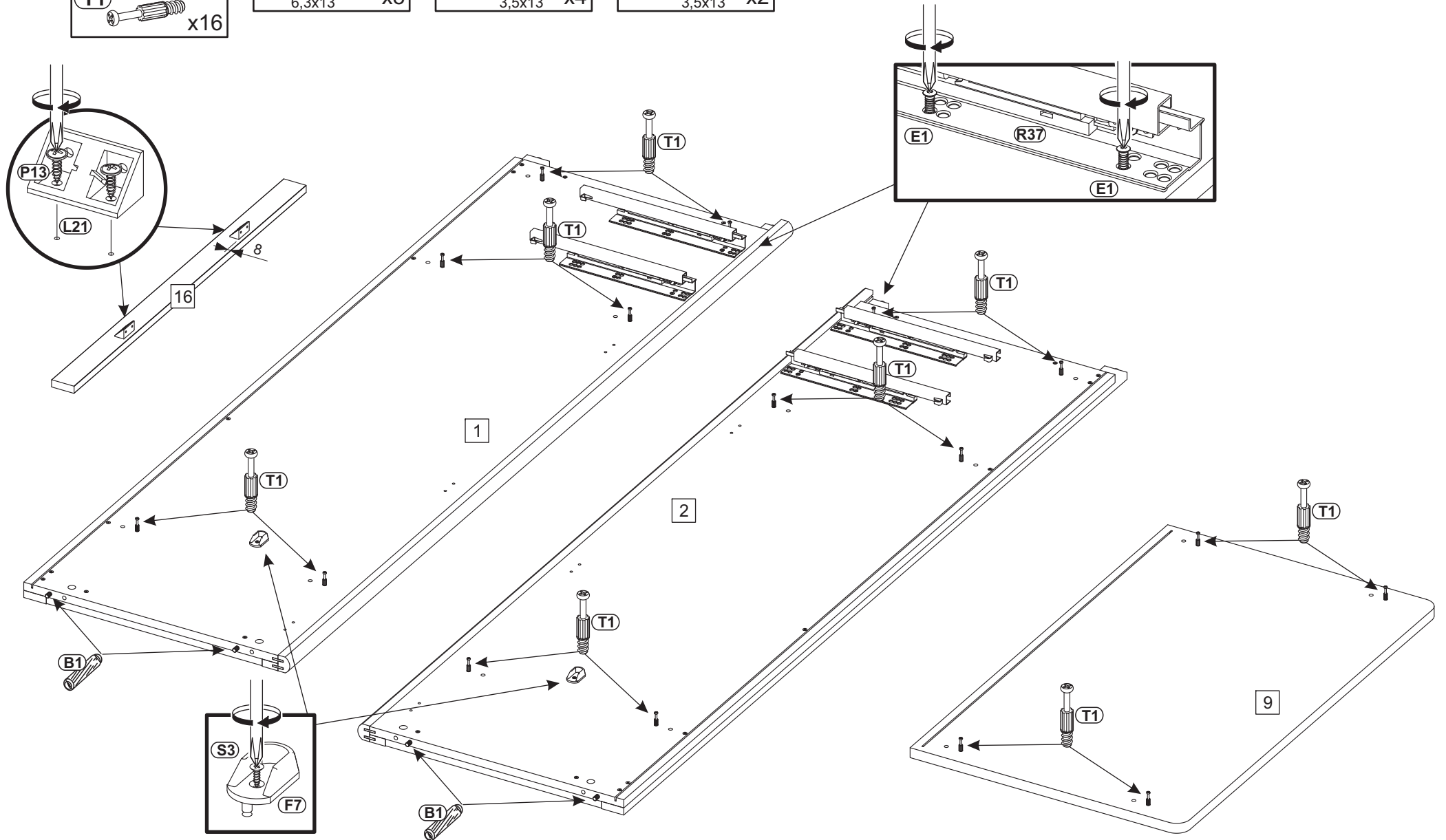
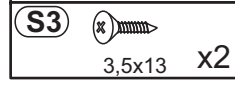
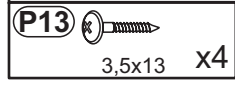
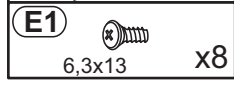
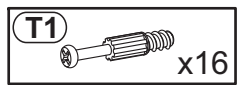
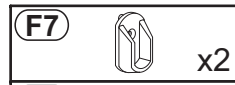
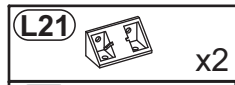
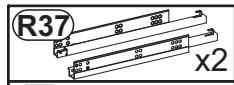
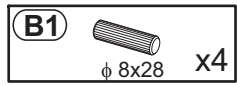

2



3

- X6**  x6
- S9**  4x16 x12
- D9**  x6

- B1**   $\phi$  8x28 x12

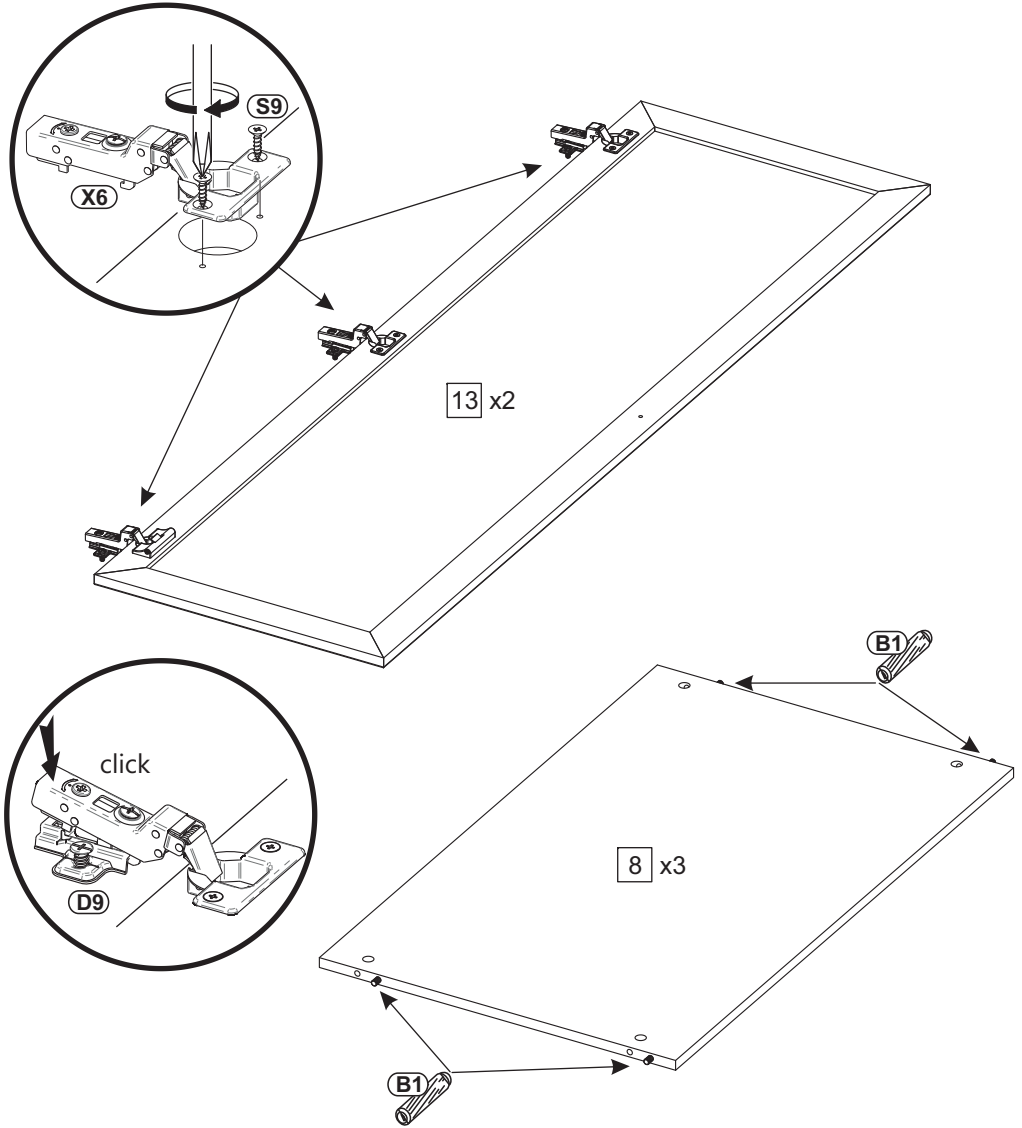

4

- F15**  x4

- M1**  x12

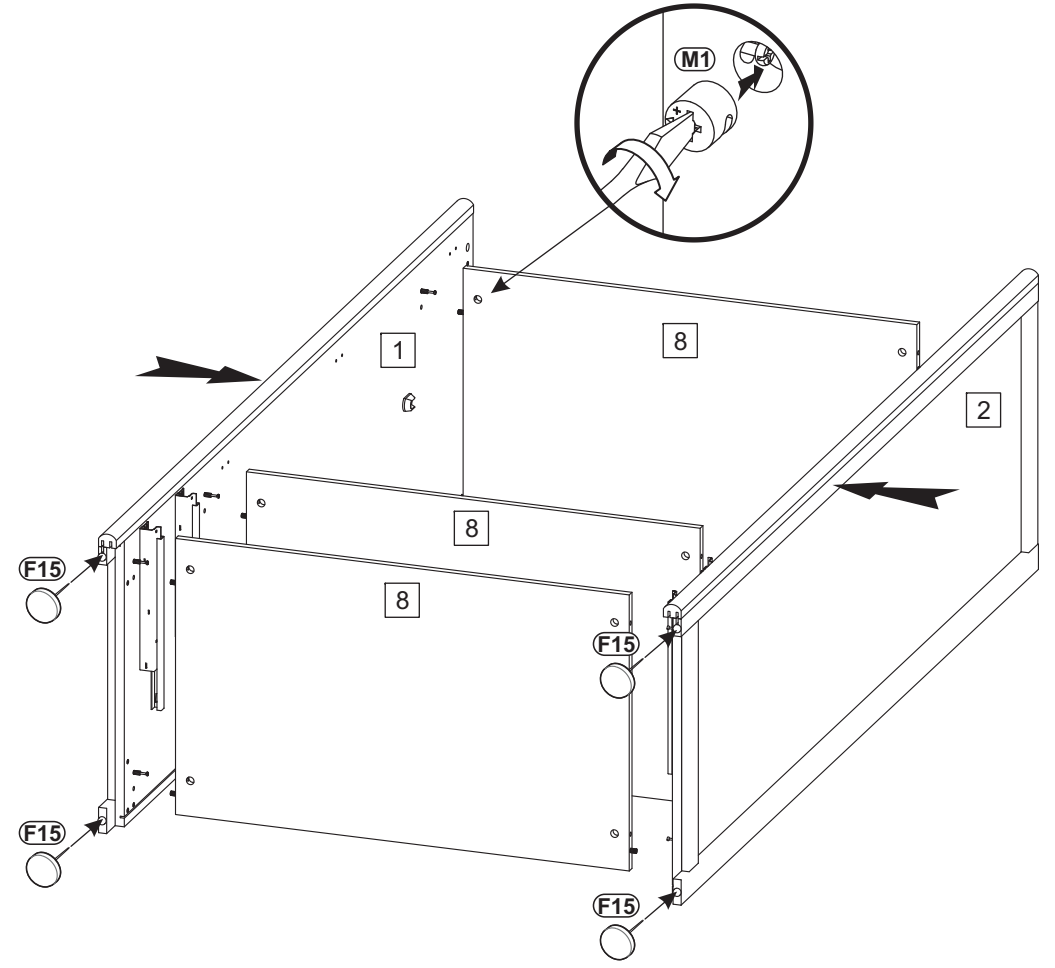

5

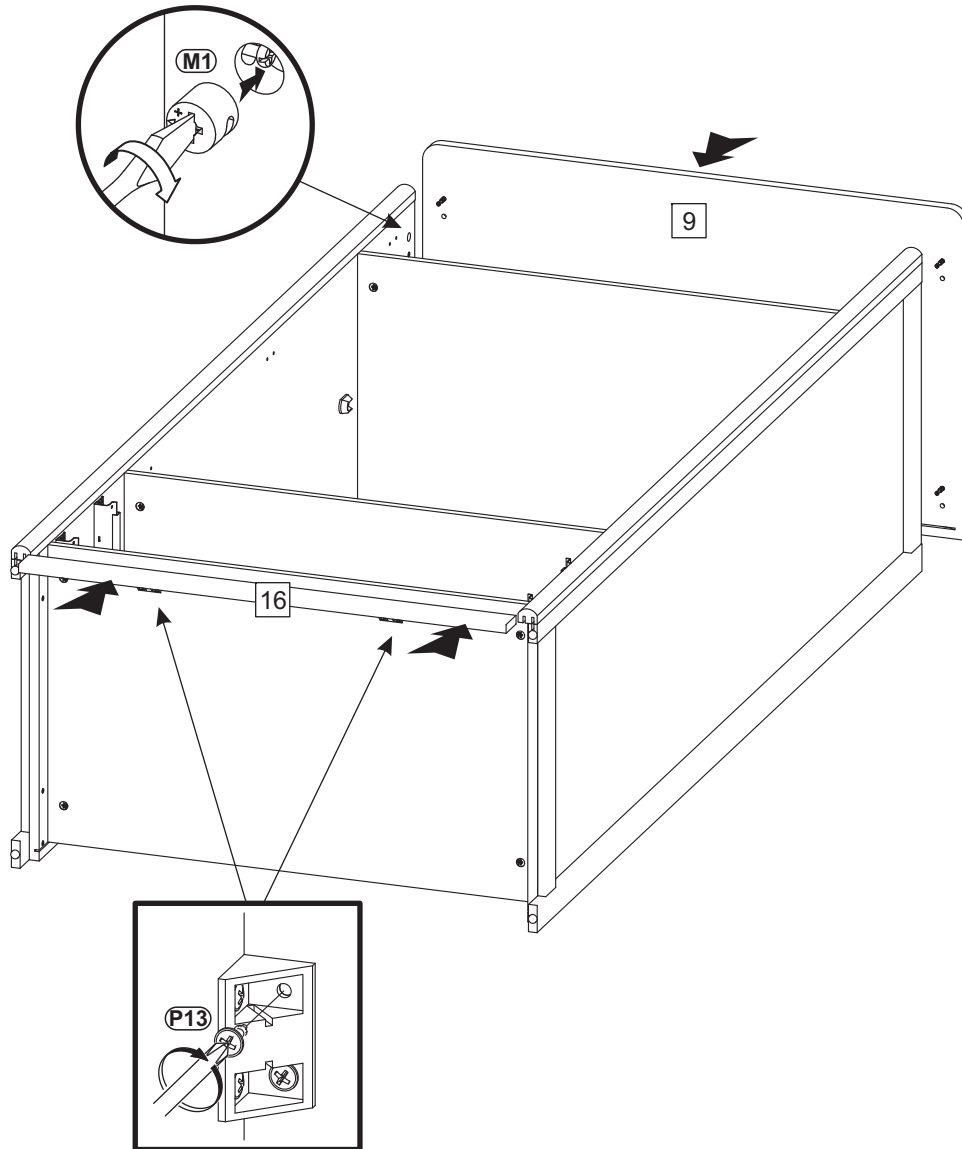
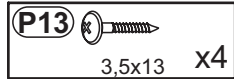

6

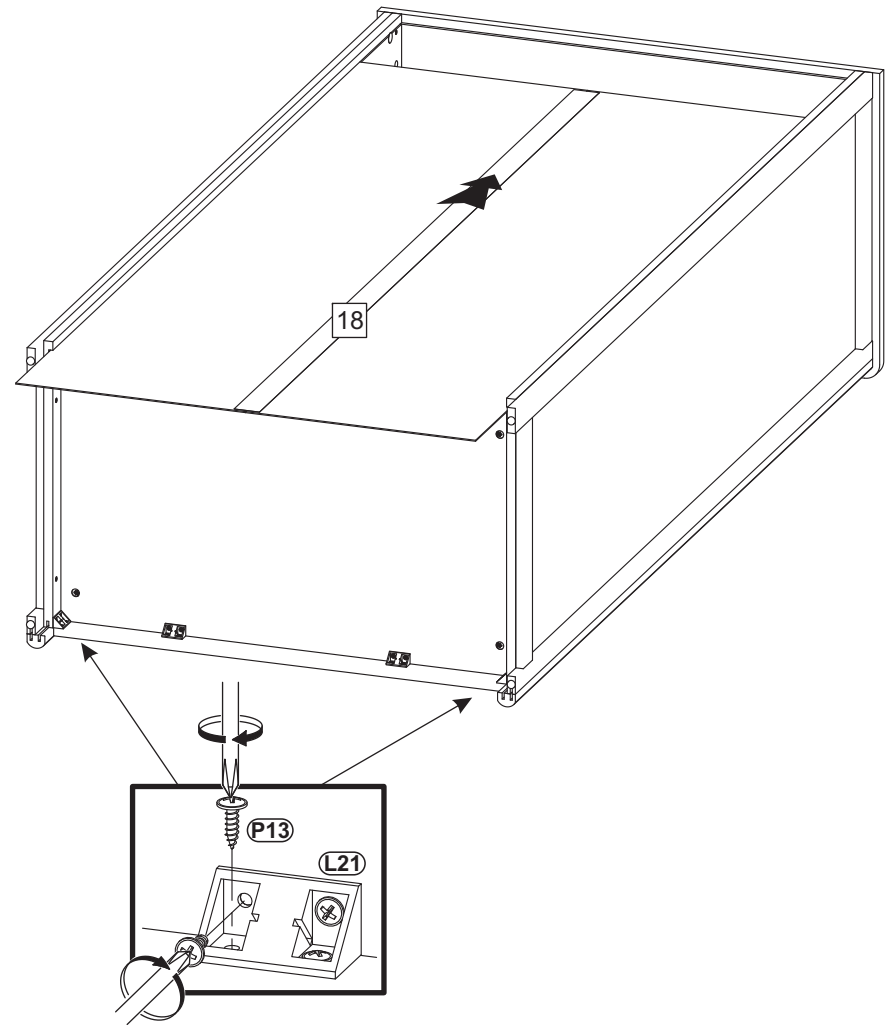
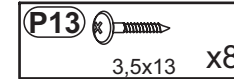
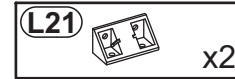

7

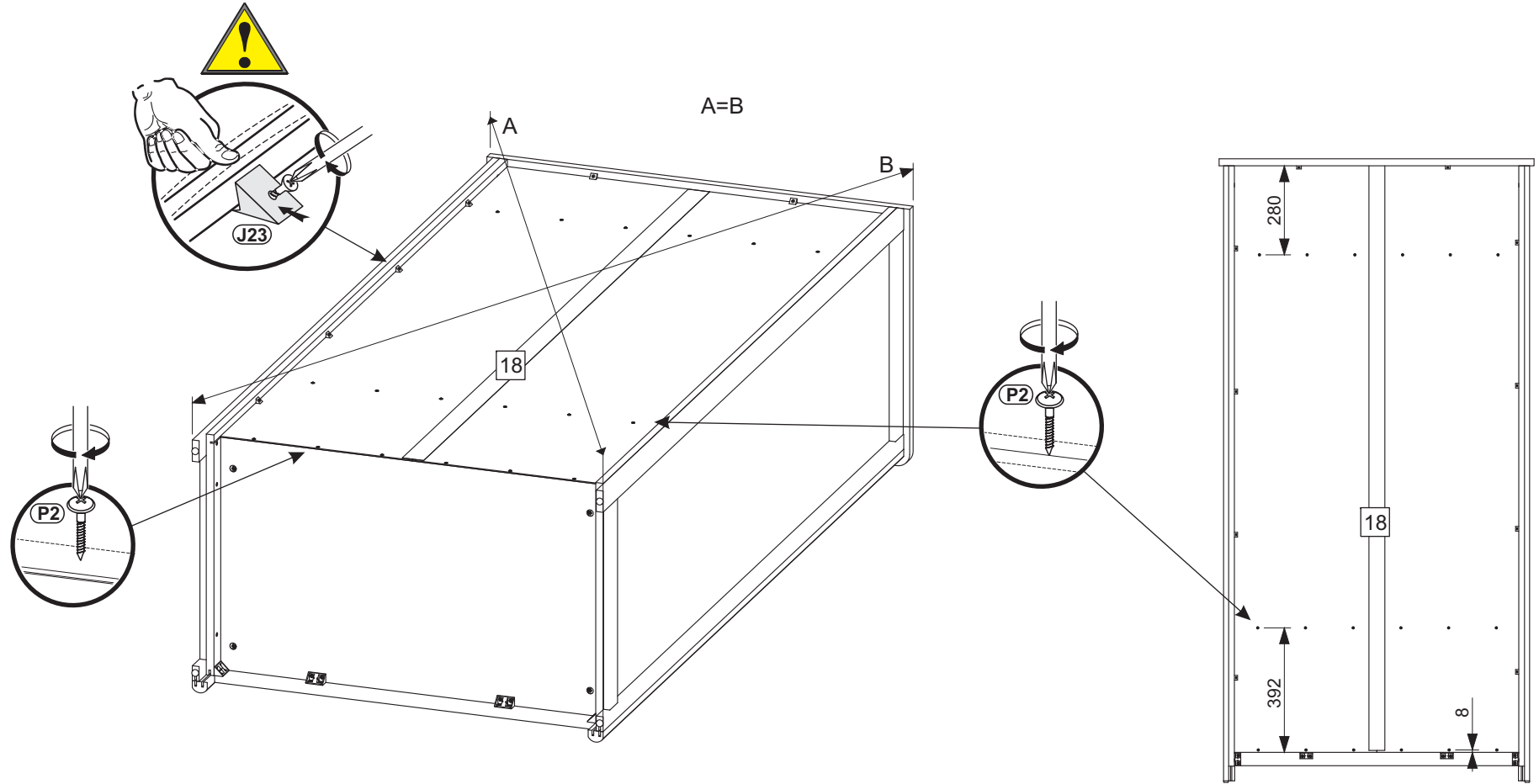
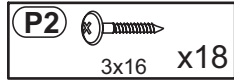
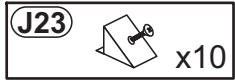

8

