

MONTAGEANLEITUNG

INSTRUKCJA MONTAŻOWA

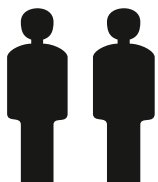

2 Personen
2 Osoby

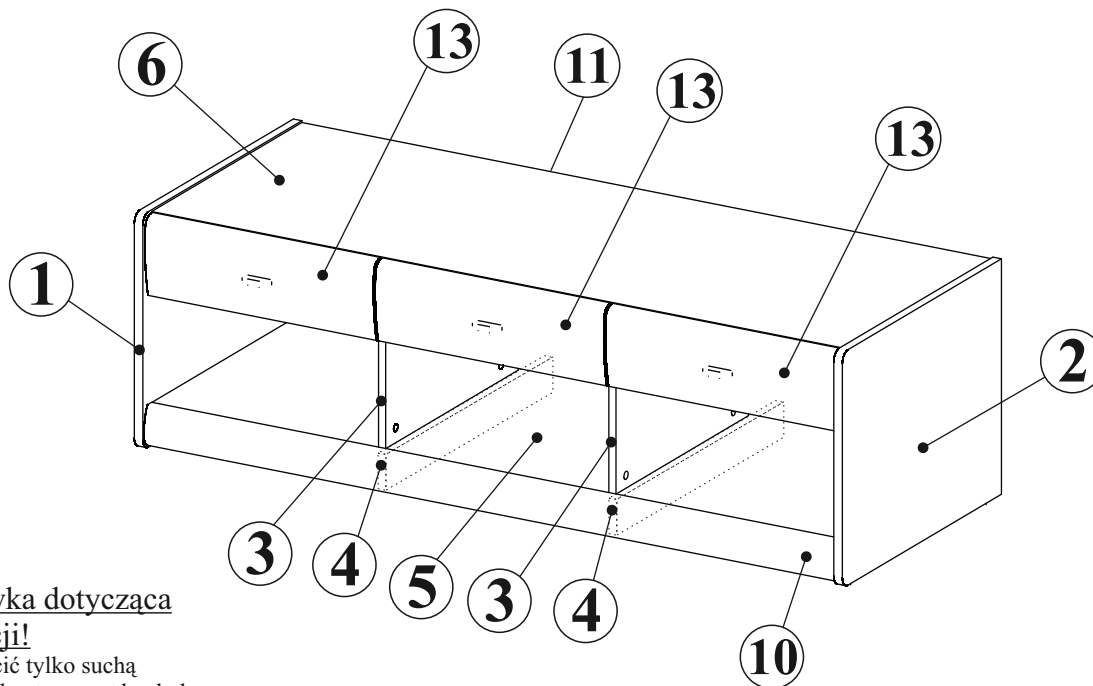
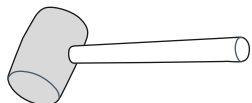
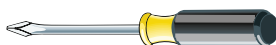
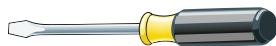
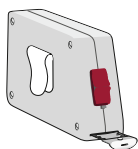

Wskazówka dotycząca pielęgnacji!

Proszę czyścić tylko suchą lub lekko wilgotną szmatką do kurzu.
 Nie używać żadnych środków szorstkich!
 Maksymalne obciążenie półek w kg:

Stärke/Gr.	Spanplatte/Płyta		
Länge/Dł. mm	15	18	22
0<400			
401<600	40	40	40
601<800	24		
801<1000	15	30	

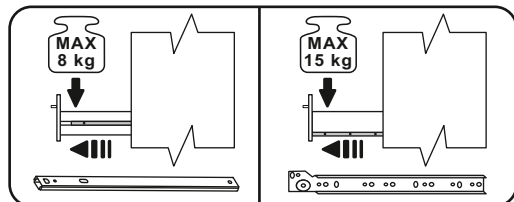

MONTOWAĆ NA ROZŁOŻONYM KARTONIE!

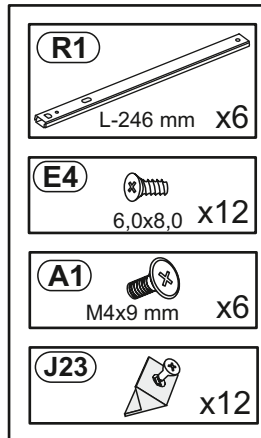
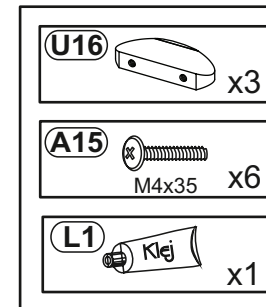
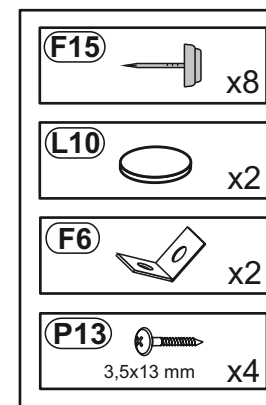
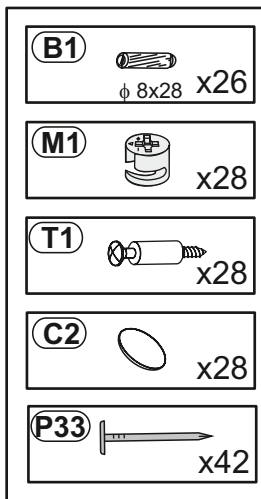
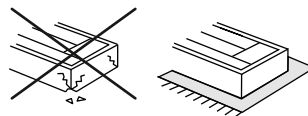

1

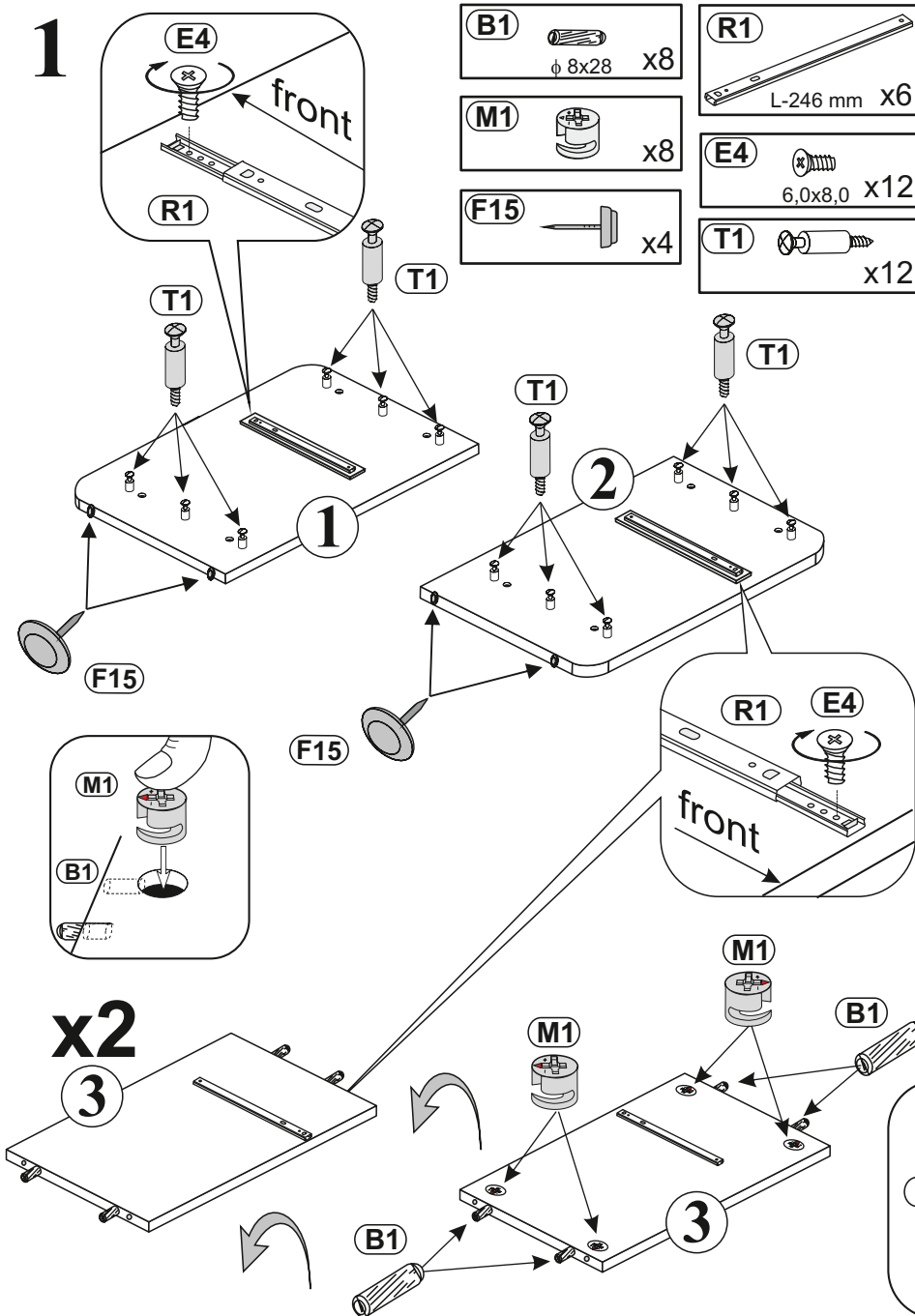

2

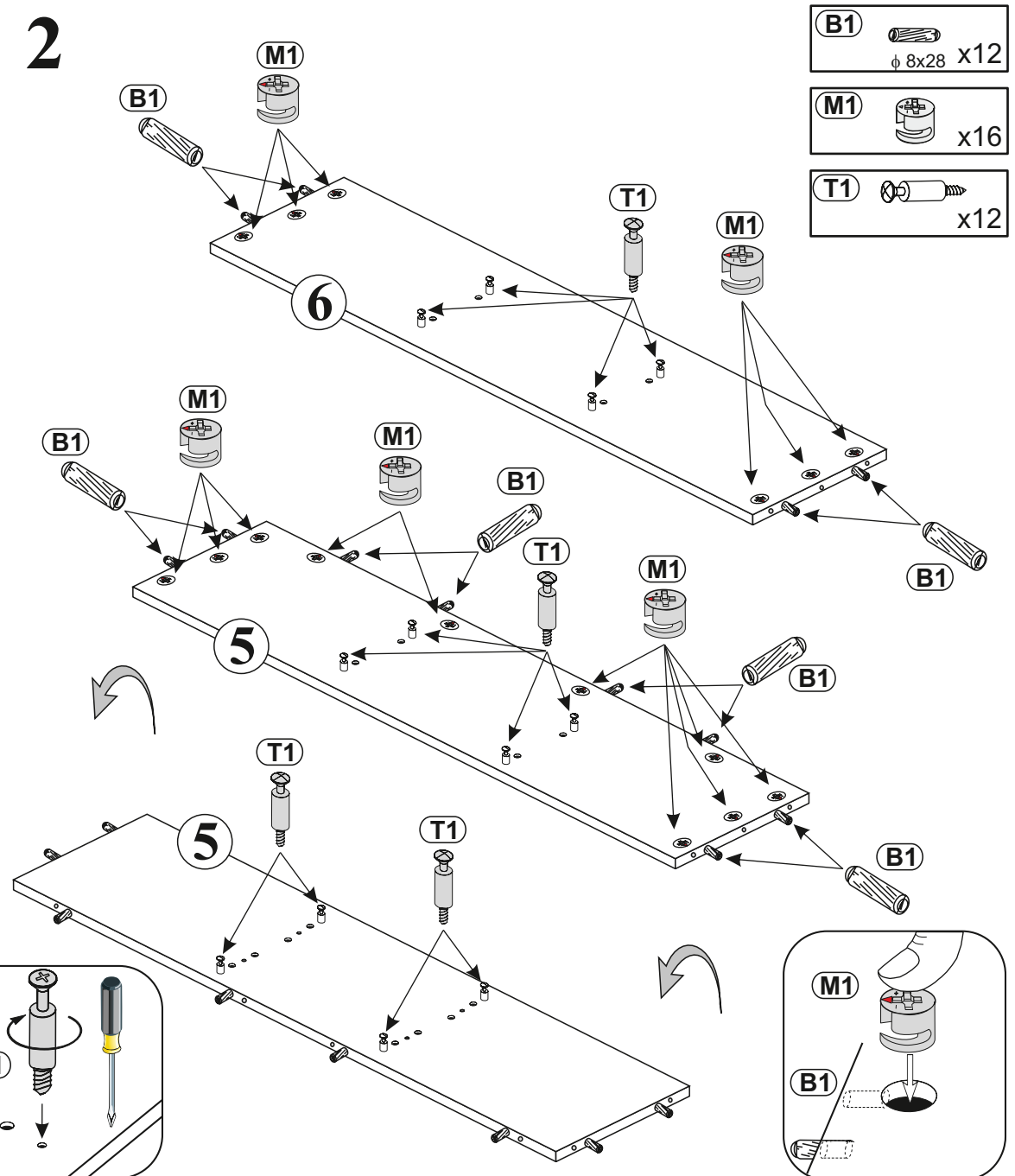

3

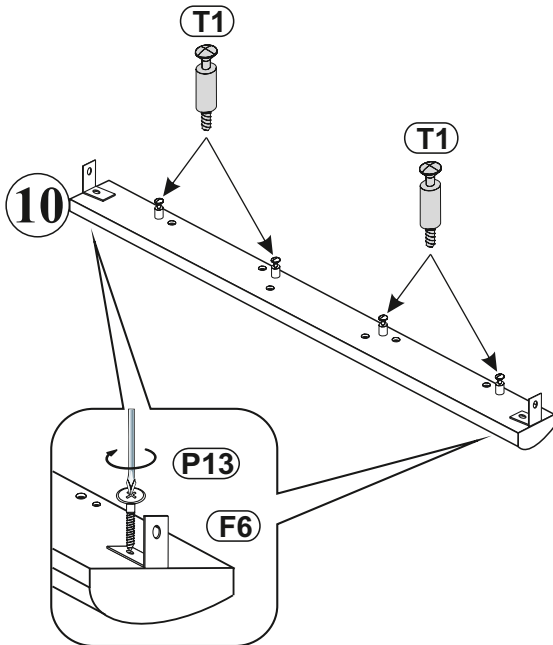
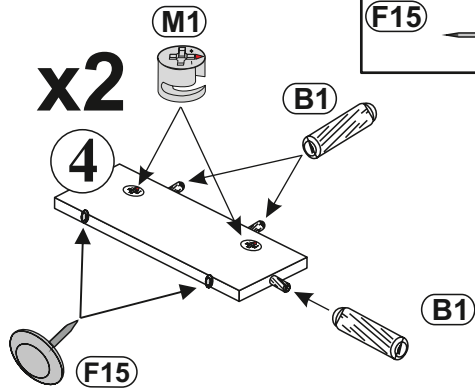
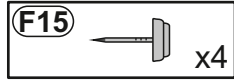
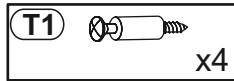
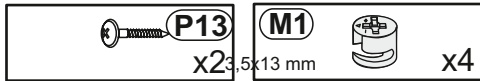

4

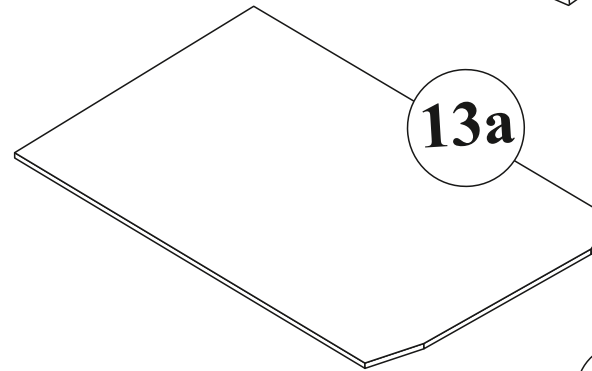
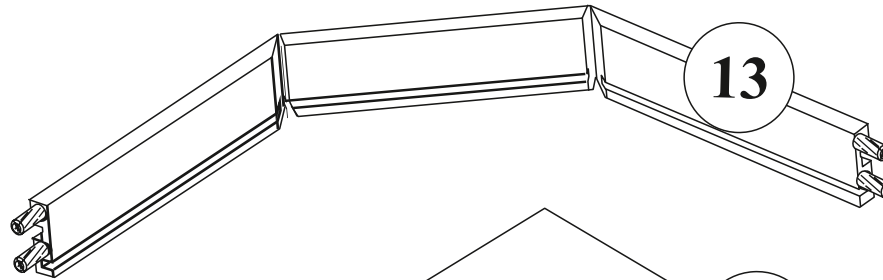

x3

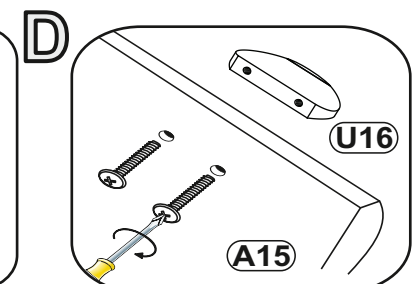
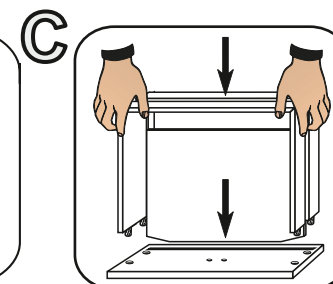
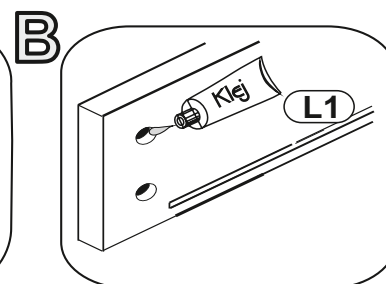
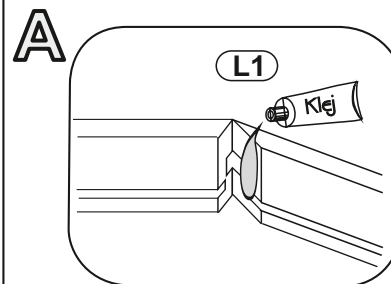
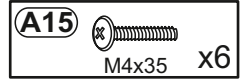
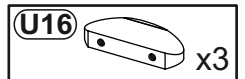
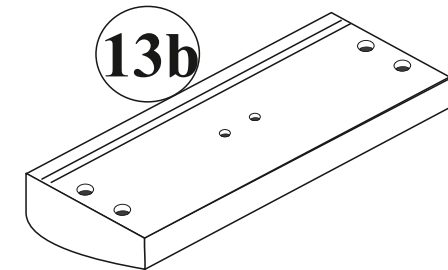

5

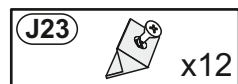
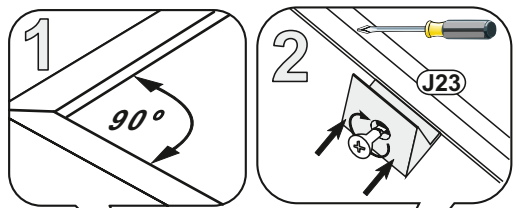

3x

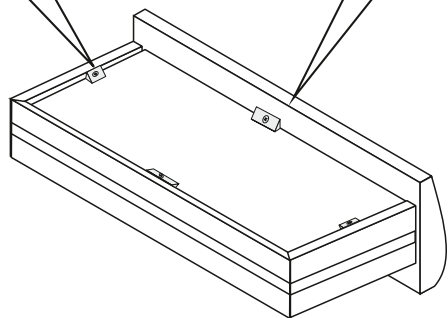

8

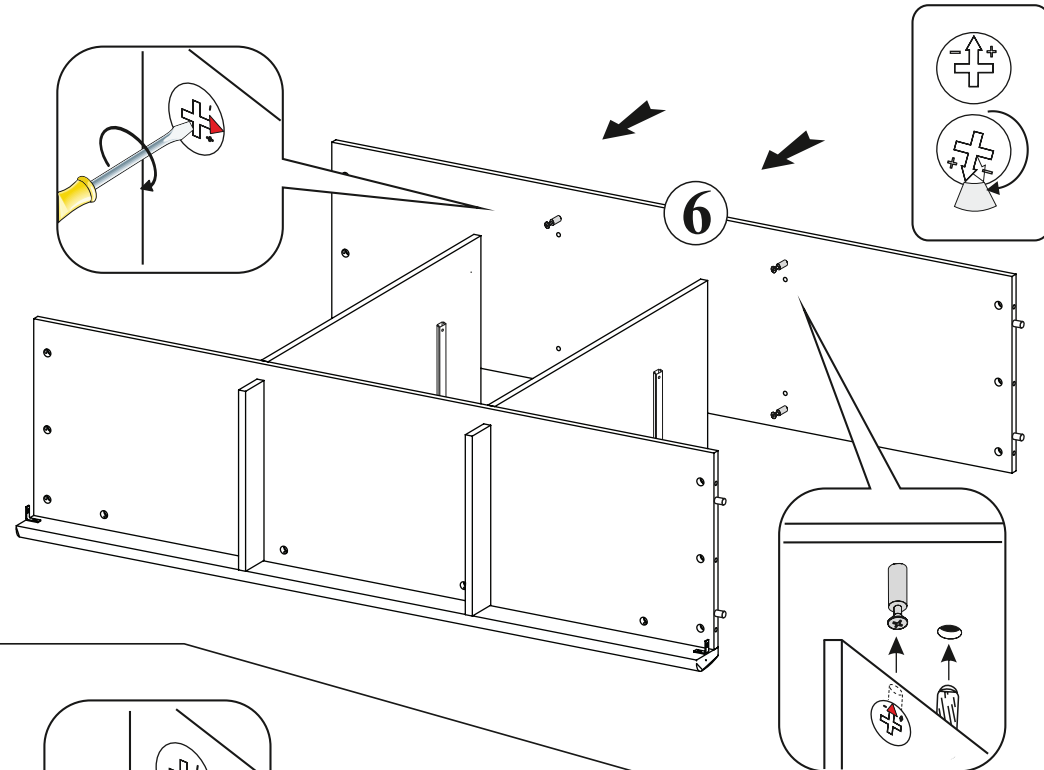

6

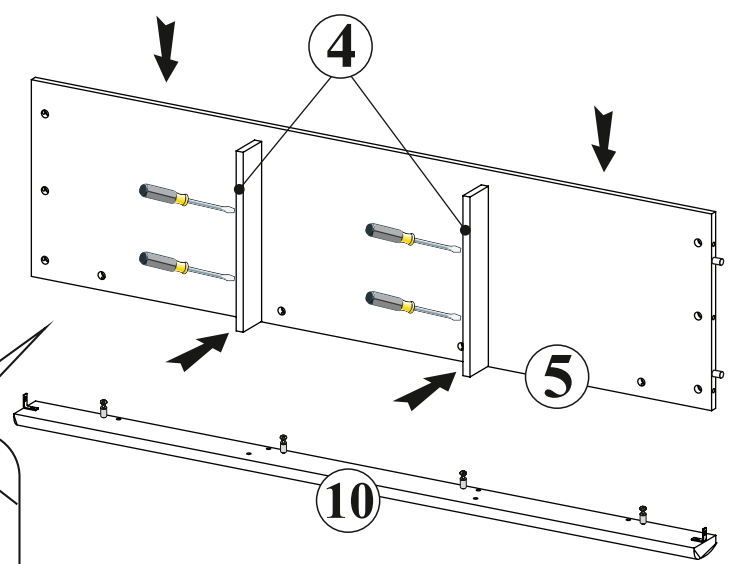

7

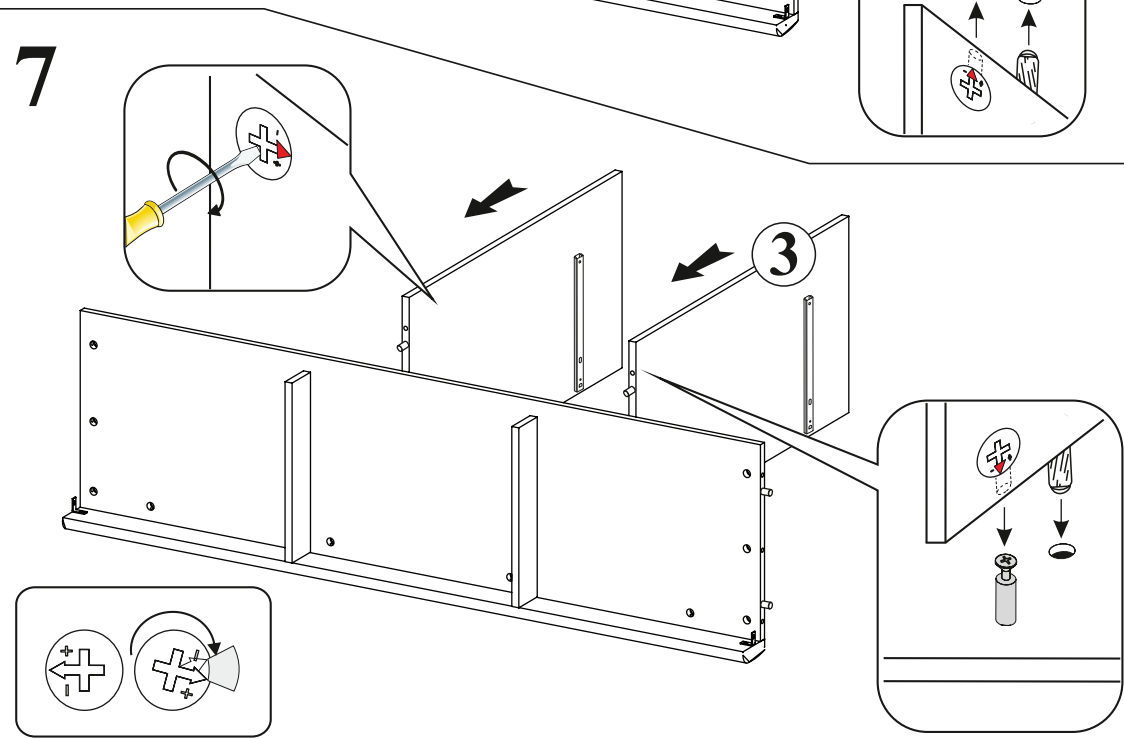

9

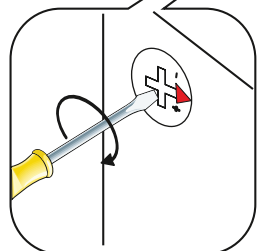
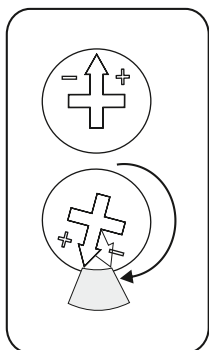
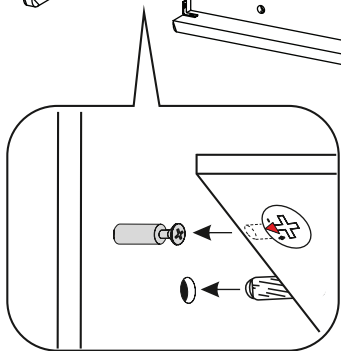
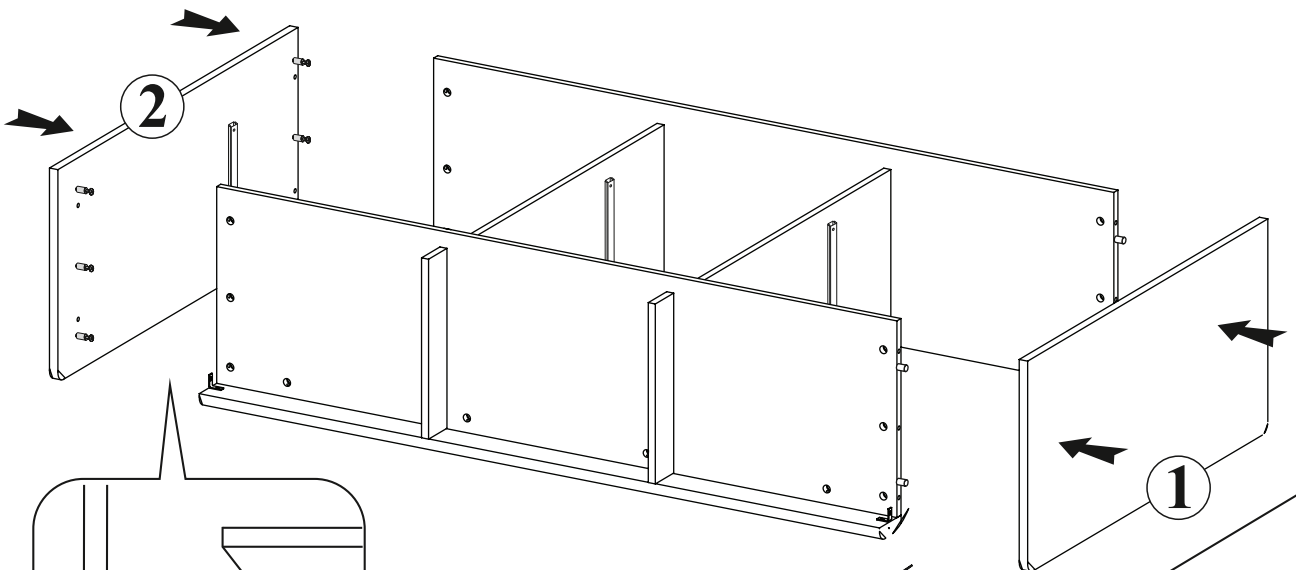

10

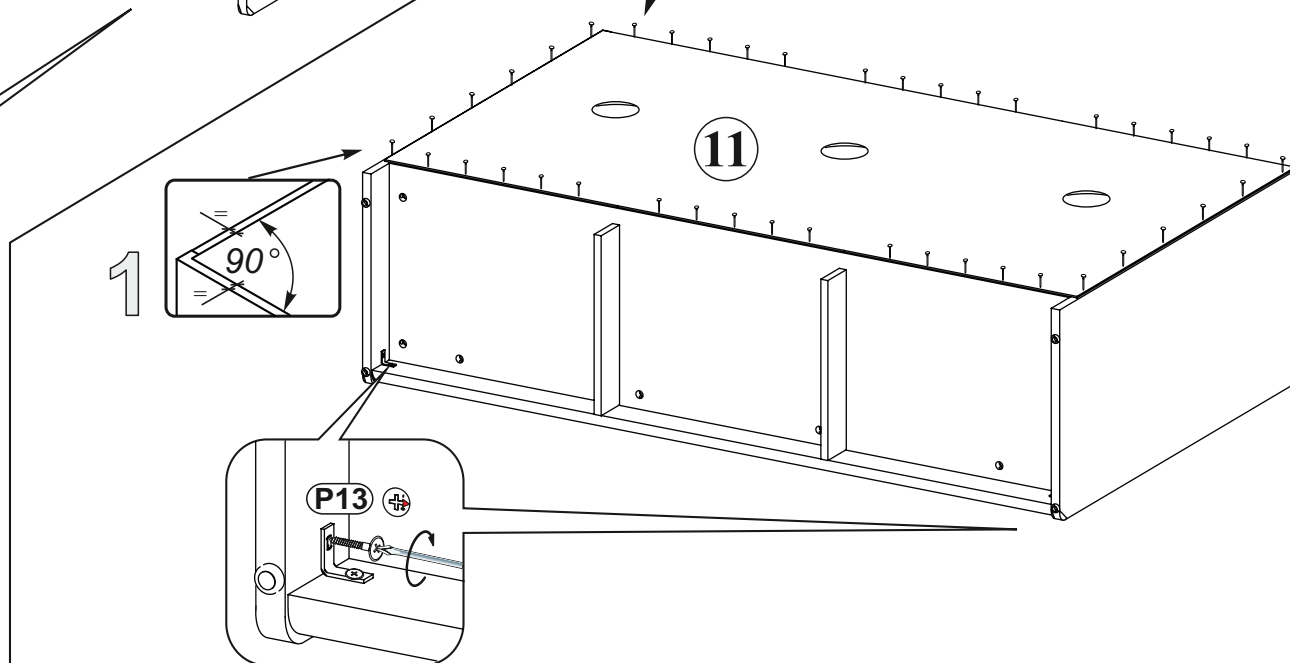

1

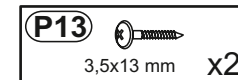
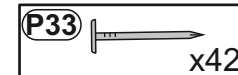
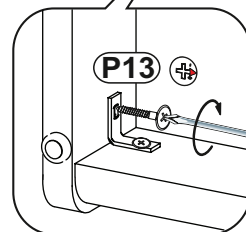
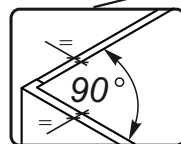

11

