

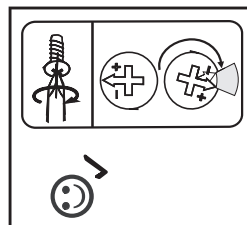

- (GB)** Assembly instructions
- (DE)** Montageanleitung
- (FR)** Notice de montage
- (NL)** Handleiding voor de montage
- (IT)** Istruzioni di montaggio
- (HU)** Szerelési útmutató
- (ES)** Instrucciones de montaje
- (PL)** Instrukcja montażu
- (CZ)** Montážní návod
- (SK)** Návod na montáž
- (HR)** Montaže
- (TR)** Montaj talimat
- (RO)** Instrucțiuni de montaj
- (RU)** Чиндөөчү дӛ эйирчӛ

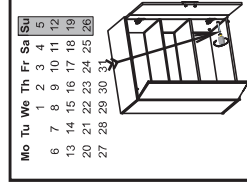
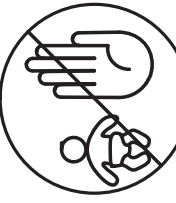
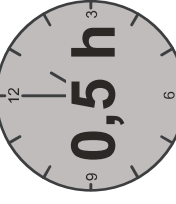
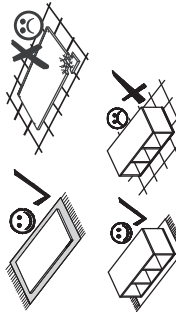
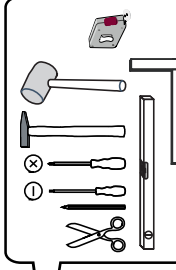
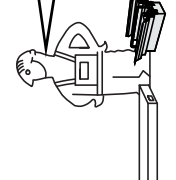
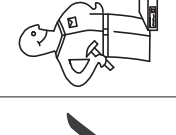
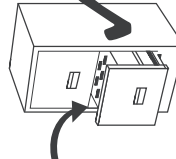
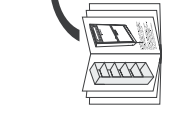
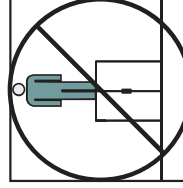
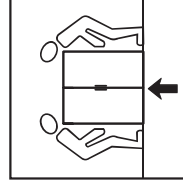
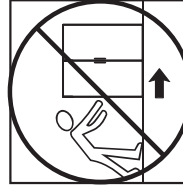
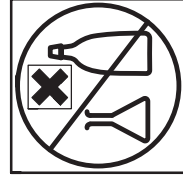
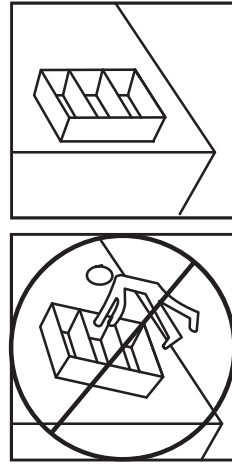
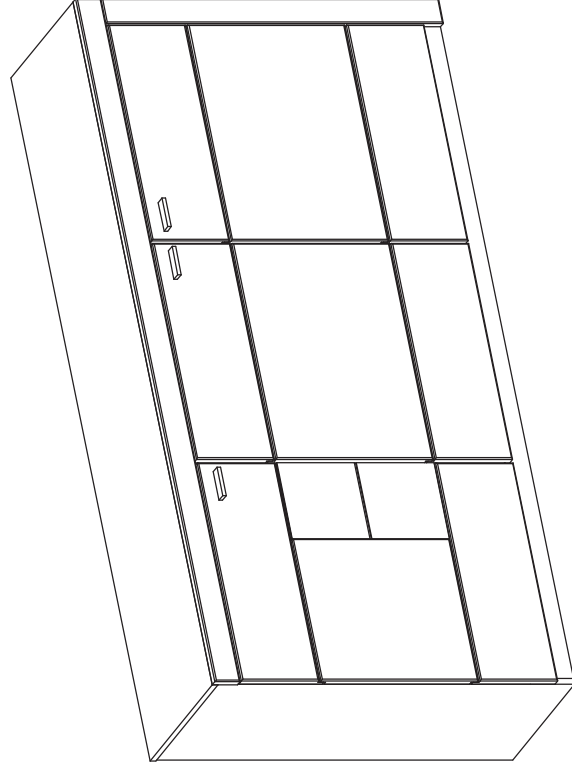

Service • Assistenza • Dienstverlening • Servis
Servis • Szerviz • Servizio • Usluga • Nírdáchnír' Néocár

Name • Nom • Naam • Nazwa
 Jméno • Názov • Név • Denimire
 Nombre • Ime • Isim • Ifrãirfíl

VELLE

Nr. • No. • N° • říeld • Ć • Sz • Ne

SIDM31..

Typ • Type • Tip • Tipus • Tipo • říedř

45

shop • geschäft • boutique • sklep • winkel • éřírřci
 negozio • bolt • tienda • obchod • dućan • maďaza • magazin

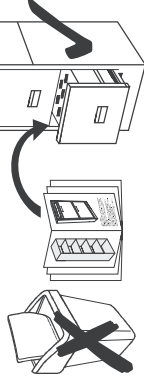
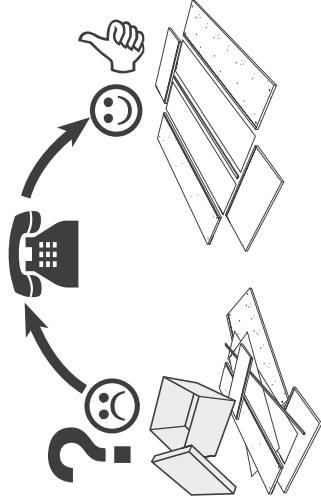

max. 4KG 06 07 08

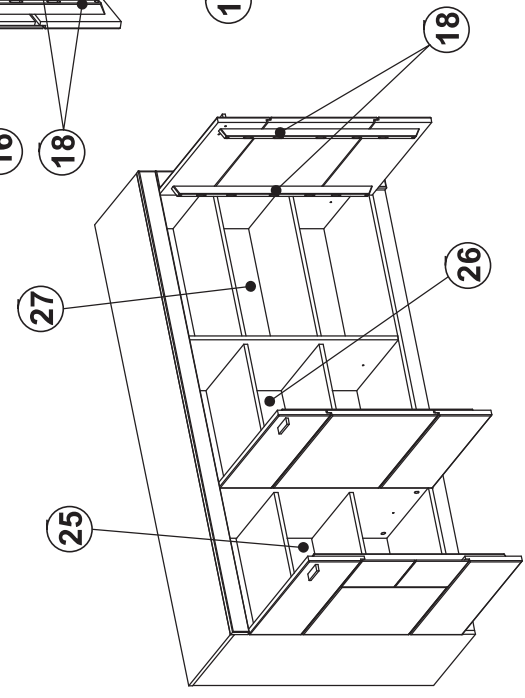
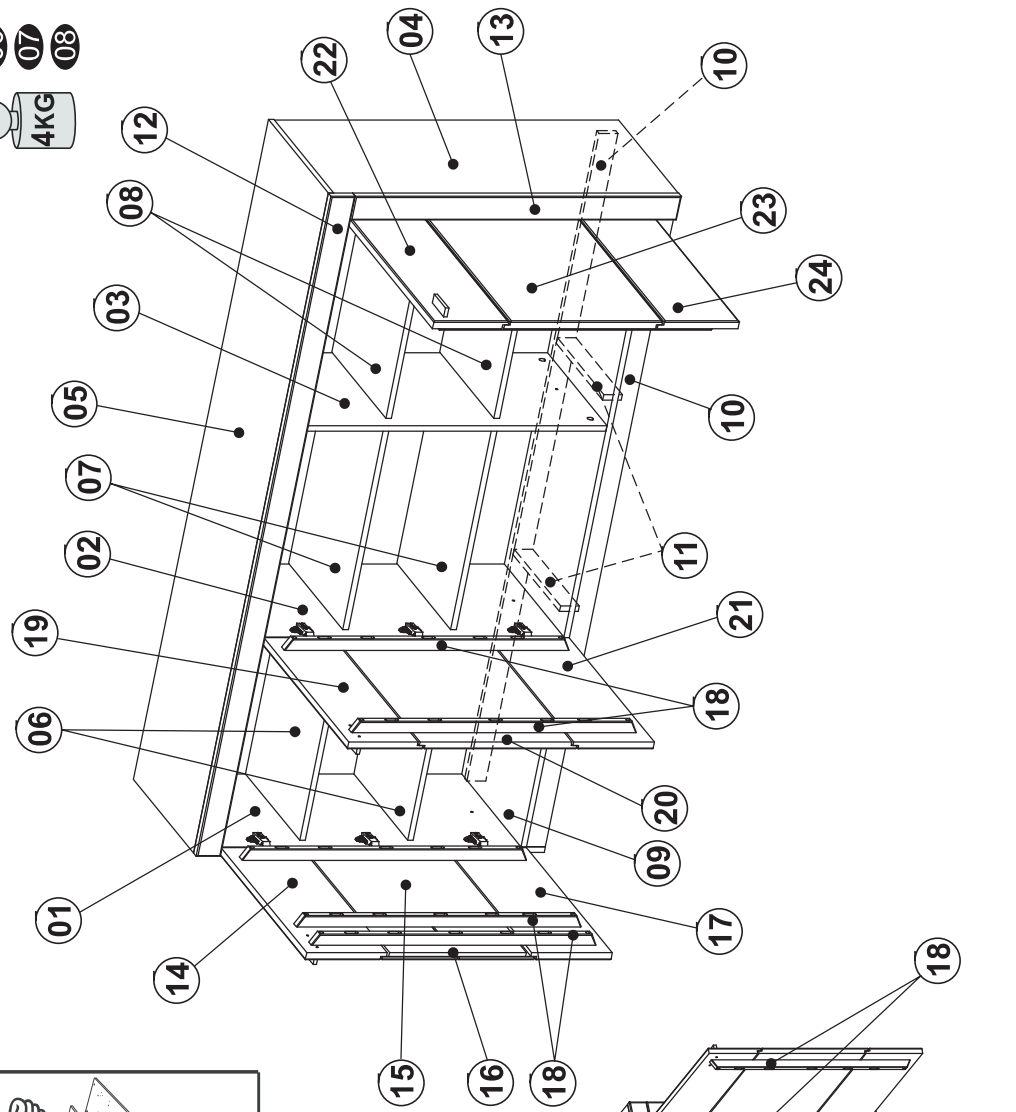

Z18 KR90	Z18s KR90	D18 H6	S9 4x16	Z2 KR8	Z2s KR8	D3 H4
T1 X...	M1 X...	B1 ří 8x28	F1 X...	Z2 KR0	Z2s KR0	D13 H2
P6 4x35	P26 3x20	W10 X...	S11 4x25	D13 X...	P6 X...	P26 X...
Z2 KR8	Z2s KR8	D13 X...	P6 X...	W10 X...	S11 X...	D3 X...



1

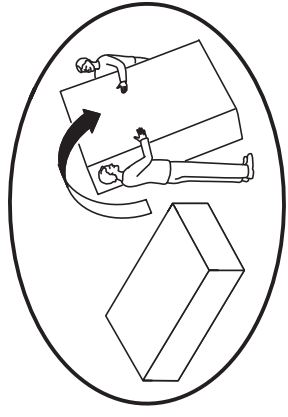
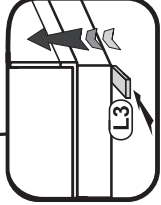
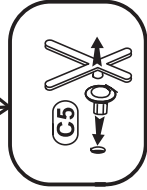
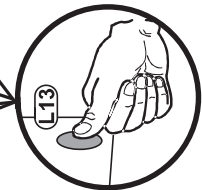
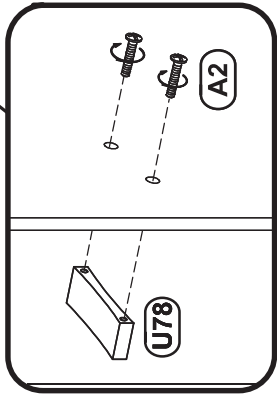
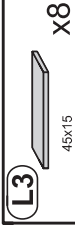
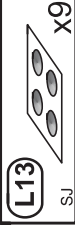
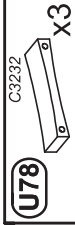
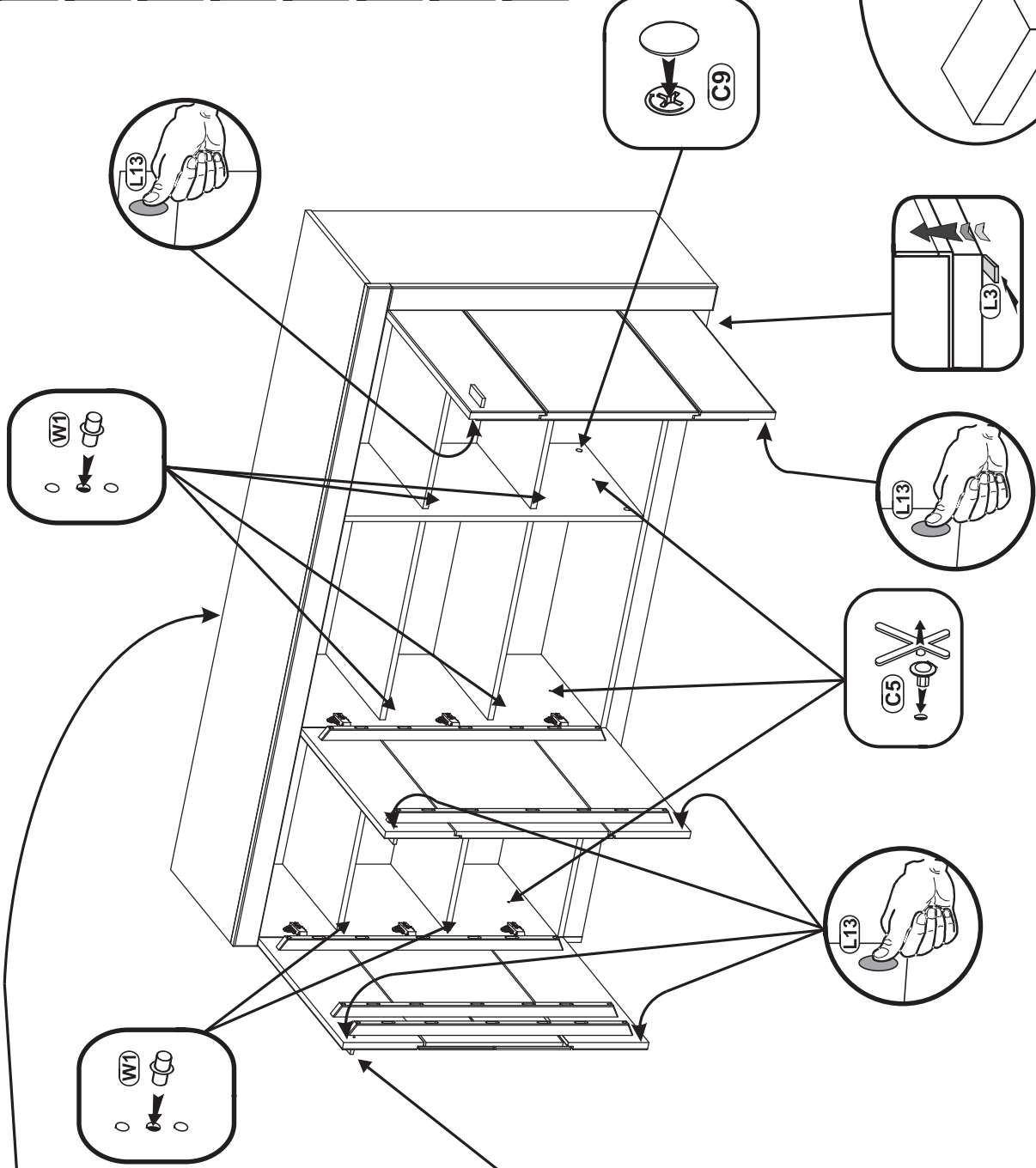
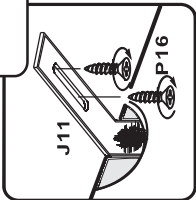
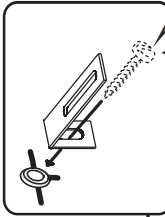

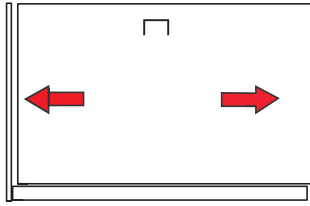

1

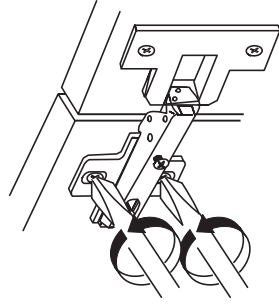

2

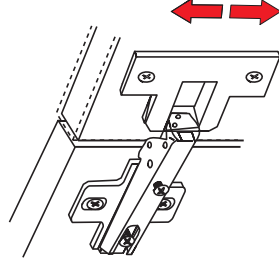

3

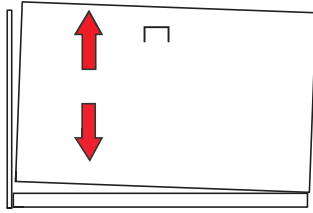
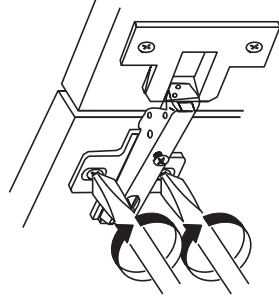

1

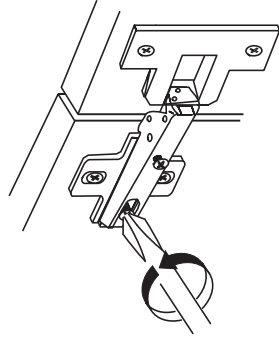

2

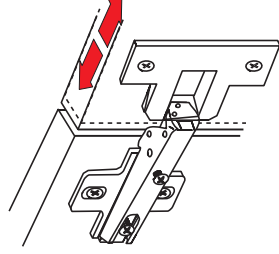

3

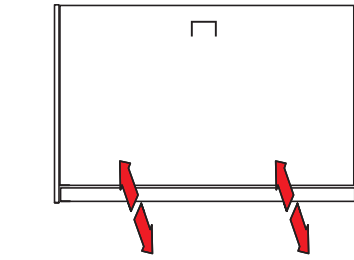
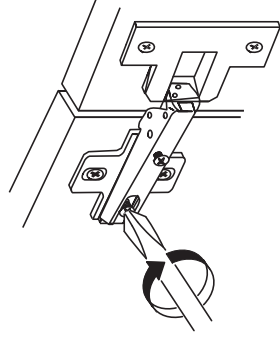

1

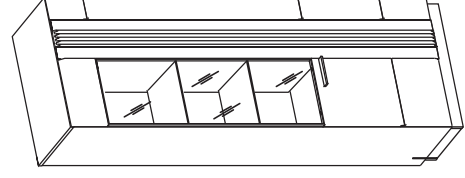
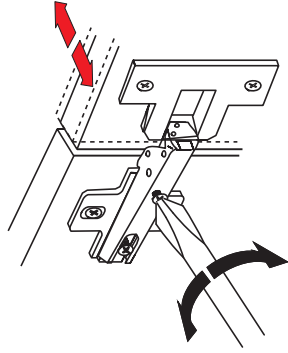

<p>Solid wood and natural veneer product information: Wood is a living product of nature that can vary in colour and structure. It is formed through natural fusions and bifurcations. Knots and diverse figures are typical features of natural wood, and cannot be complained about. Change in climate can result in small cracks and warps on the surface of the furniture. Each trunk yields wood of different appearance, figure and colour. Differences in colour that can appear on both veneer and wood after dyeing are a natural feature of wood and cannot be complained about. Every type of wood responds to changes in the environment and air humidity. At an optimum temperature of 20°C and a humidity of 40-70%, wood works only slightly. Maintenance involves regular cleaning of the external and internal surfaces of the furniture. Remove stains and dirt on a regular basis. Recommended materials and maintenance products: soft cloths used with appropriate cleaning and maintenance products. Test them in a non-prominent place before use.</p>	<p>Informace o výrobku z masivního dřeva a přírodní dýhy: Dřevo je živý produkt přírody s různými barvami a strukturami. Se vytváří přirozenými slisy a větveny. Slabá i tvrdá lehkostní isny typické prvky přirozeného dřeva a nedávají důvod k reklamaci. Změna klimatu může vést k vzniku malých trhlin nebo návalu a barvových prasklin nebo deformací. Každý kmen dává dřeva různého vzhledu, lesklého a barevného, a barvové odlišnosti dřeva a dřeva jsou přirozenou vlastností dřeva a nedávají důvod k reklamaci. Každý druh dřeva reaguje na změny v životním prostředí a vlhkosti vzduchu. Při optimální teplotě 20°C a vlhkosti 40-70%, dřeva funguje jen mírně. Údržba zahrnuje pravidelné čištění vnějších i vnitřních povrchů nábytku. Odstraňte pravidelně skvrny a nečistoty. Doporučené materiály a prostředky na údržbu: úšlechky z měkké tkaniny s příslušnými prostředky čistící a na údržbu. Před použitím udejte je test na skryté oblasti.</p>	<p>Información sobre el producto de madera maciza y chapa natural: La madera es un producto vivo de la naturaleza que puede variar en color y estructura. Se forma a través de fusiones y ramificaciones naturales. Nudos y diversas figuras son características típicas de la madera natural y no pueden ser objeto de reclamación. Cambios climáticos pueden resultar en pequeñas grietas y deformaciones en la superficie del mueble. Cada tronco da una madera de apariencia, figura y color diferentes. Las diferencias de color que pueden aparecer tanto en la chapa como en la madera después de la decoloración son una característica natural de la madera y no pueden ser objeto de reclamación. Cada tipo de madera responde a los cambios en el medio ambiente y la humedad del aire. A una temperatura óptima de 20 °C y una humedad del 40-70%, la madera trabaja solo un poco. El mantenimiento consiste en limpiar regularmente las superficies externas e internas de los muebles. Elimina manchas y ensuciamientos sobre. Materiales y productos de mantenimiento recomendados: paños blandos con productos de limpieza y mantenimiento adecuados. Antes de su uso, pruébelos en un lugar invisible.</p>	<p>Informazione sul prodotto di legno massiccio e impiallacciatura naturale: Il legno è un prodotto vivente della natura che può variare in colore e struttura. È formato attraverso fusioni e diramazioni naturali. Nodi e diverse figure sono le caratteristiche tipiche del legno naturale e non possono essere oggetto di reclamo. Cambiamenti climatici possono risultare in piccole fessure e deformazioni e intarsiamenti piccoli sulla superficie del mobili. Ogni fusto dà un legno di differente aspetto, figura e colore. Differenze di colore possono apparire sia sulla chapa che sulla lamiellaccatura sia sul legno dopo la decolorazione sono una caratteristica naturale del legno e non possono essere oggetto di un reclamo. Ogni tipo di legno risponde ai cambiamenti ambientali e di umidità. Con una temperatura ottimale di 20 °C e un'umidità di 40-70%, il legno lavora solo poco. La manutenzione consiste nella pulizia regolare delle superfici esterne ed interne del mobile. Rimuovere regolarmente macchie e sporcizie. Materiali e mezzi di manutenzione raccomandati: stracci morbidi con mezzi di pulizia e di manutenzione adatti. Prima dell'uso provarle in un luogo invisibile.</p>
<p>Informacja o produkcie z drewna litego i okleinie naturalnej: Drewno jest żywym produktem natury o różnym kolorze i strukturach. Powstaje ono przez naturalne zrosty i rozgałęzienia. Skoki oraz różnorodność usłojenie są charakterystycznymi cechami naturalnego drewna i nie dają podstawy do reklamacji. Zmiana klimatu może prowadzić do powstawania na powierzchni mebla małych rys lub wypaczania. Drewno z każdego pnia ma inny wygląd, inne usłojenie i kolorystyke. Różnice kolorystyczne po wybarwieniu występujące na okleinie czy też drewnie są naturalną cechą drewna i nie podlegają reklamacji. Każde drewno reaguje na zmiany otoczenia i wilgotności powietrza. Opтимальная температура около 20°C i влажносtи 40-70% powoduje tylko nieznaczny pracę drewna. Konservacja polega na regularnym czyszczeniu zewnętrznych i wewnętrzych powierzchni mebla. Nie bieżąco usuwać plamy i zabrudzenia. Zalecane materiały i środki konserwacji: sьciereczki z miękkiej tkaniny z użyciem odpowiednich środków czyszcząco-konserwujących. Przed użyciem przeprowadzć test na nie widocznej powierzchni.</p>	<p>Podatci o proizvodnizi z drewna litego i prirodnoh stapanje: Drevo je živ proizvod prirode i može varirati u boji i strukturi. Povstaje ono kroz prirodno stapanje i račvanje. Skokovi i različiti uslojenja su karakteristični prirodnoh drva, stoga ne mogu biti predmet prigovora. Promjene u klimi mogu prouzročiti male pukotine i izrivljenosti na površini namještaja. Svako drbo daje drugaćijeg izgleda, oblika i boje. Razlike u boji, koje se mogu pojaviti u lamini i na drvu nakon bojanja i prirodna su značajka drva i na to se ne može prigovoriti. Svaka vrsta drva reagira na promjene u okolini i vlažnosti zraka. Na optimalnoj temperaturi od 20°C i vlažnosti zraka od 40-70% promjene na drvu neznatno čišćenje vanjskih i unutarnjih površina namještaja. Redovito uklanjajte mrlje i prašinu. Opmirnjava temperatura oko 20°C i vlaga 40-70% dovodi samo do minimalnih promjena u strukturi i boji. Preporučena sredstva i materijal za čišćenje: mekane krpe korištene zajedno s prikladnim sredstvima za čišćenje i održavanje. Isprobajte ih najprije na površini koja nije vidljiva.</p>	<p>Información sobre el producto de madera maciza y chapa natural: La madera es un producto vivo de la naturaleza que puede variar en color y estructura. Il se forme par des groupements et branchements naturels. Nodos y diversas figuras son características típicas de la madera natural et il peuvent pas faire l'objet d'une réclamation. Les changements climatiques peuvent avoir pour effet de petites fissures et gauchissements sur la surface du meuble. Chaque tronc donne un bois d'apparence, de stature et de couleur différente. Les différences de couleur qui peuvent se produire, après la teinture, aussi sur le placage que sur le bois sont une caractéristique naturelle du bois et il ne peuvent pas être l'objet d'une réclamation. Chaque type de bois réagit aux changements environnementaux et d'humidité de l'air. A une température optimale de 20 °C et une humidité de 40-70%, le bois ne travaille pas que très légèrement. Le maintien consiste à nettoyer régulièrement les surfaces internes et externes des meubles. Éliminer régulièrement les taches et la saleté. Matériaux et produits d'entretien recommandés: lingettes douces avec les produits de nettoyage et d'entretien appropriés. Avant de les utiliser, il faut les tester à un endroit invisible.</p>	<p>Informazione sul prodotto di legno massiccio e impiallacciatura naturale: Il legno è un prodotto vivente della natura che può variare in colore e struttura. Si forma attraverso unioni e ramificazioni naturali. Nodi e diverse figure sono le caratteristiche tipiche del legno naturale e non possono essere oggetto di reclamo. Cambiamenti climatici possono risultare in piccole fessure e deformazioni e intarsiamenti piccoli sulla superficie del mobili. Ogni tronco dà un legno di differente aspetto, figura e colore. Differenze di colore che possono apparire sia sulla chapa che sulla lamina dopo la decolorazione sono una caratteristica naturale del legno e non possono essere oggetto di un reclamo. Ogni tipo di legno risponde ai cambiamenti ambientali e di umidità. Con una temperatura ottimale di 20 °C e un'umidità di 40-70%, il legno lavora solo poco. La manutenzione consiste nella pulizia regolare delle superfici esterne ed interne del mobile. Rimuovere regolarmente macchie e sporcizie. Materiali e mezzi di manutenzione raccomandati: stracci morbidi con mezzi di pulizia e di manutenzione adatti. Prima dell'uso provarle in un luogo invisibile.</p>
<p>EN</p>	<p>CS</p>	<p>ES</p>	<p>IT</p>
<p>PL</p>	<p>HR</p>	<p>FR</p>	<p>NL</p>
<p>RU</p>	<p>SK</p>	<p>HU</p>	