

















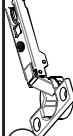

<b>B1</b>		φ 8x28	x27
<b>T1</b>			x27
<b>M1</b>			x27
<b>C2</b>		φ 20	x20
<b>C2</b>		φ 20	x12
<b>W1</b>			x12
<b>W2</b>			x12
<b>F1</b>			x12
<b>P2</b>		3x16	x28
<b>G4</b>			x10
<b>J23</b>			x12
<b>F15</b>			x6

<b>X5</b>		x7
<b>S9</b>		4x16 x14
<b>D2</b>		x7
<b>X19</b>		x2

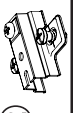
<b>L21</b>		x5
<b>P13</b>		3.5x13 x22
<b>J11</b>		x1



Nr	Ausmaß		St	Colli
	270	320		
1	270	320	5	3
2	1590	241	4	1
3	1864	383	15	1
4	1864	383	15	1
5	600	80	15	1
6	340	80	15	1
7	340	80	15	2
9	324	160	15	1
10	1864	363	15	1
11	332	345	15	1
12	271	355	15	2
13	332	345	15	3
14	224	60	15	1
15	650	384	15	1
16	650	384	15	1
19	1890	360	18	1
20	1890	284	18	1
23	1878	346	2	1
24	285	939	2	2

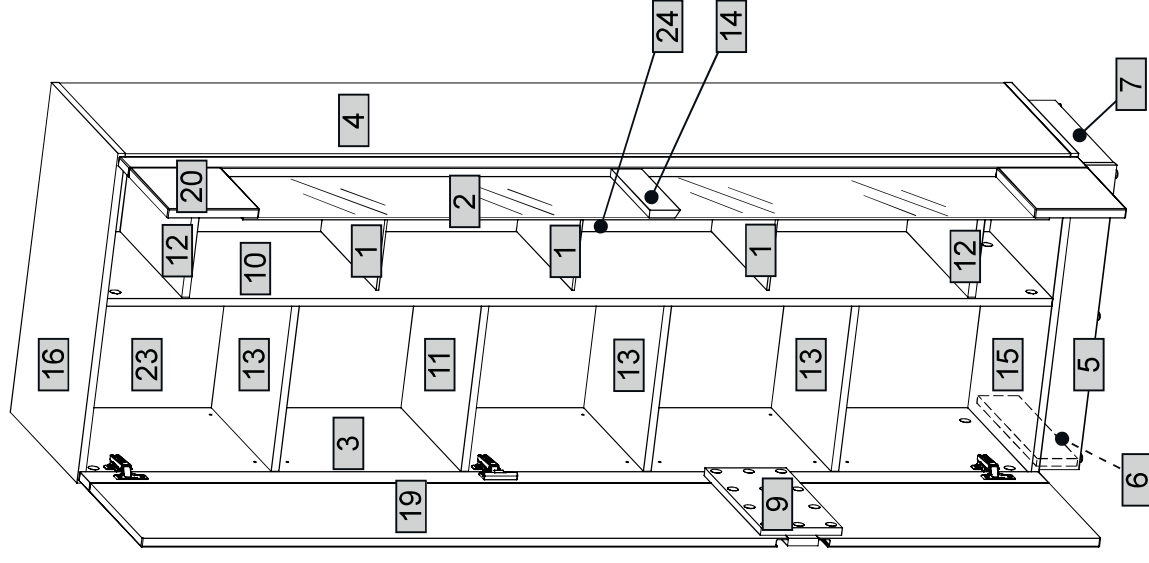

0 10 20 30 40 50 60 70 80 90 100 110 120 130 140 150 160 170 180 190 200

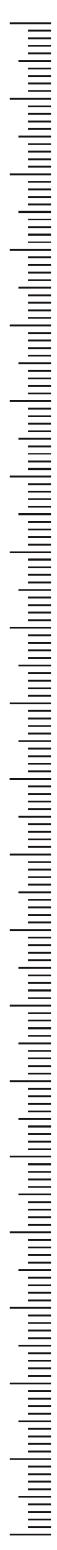

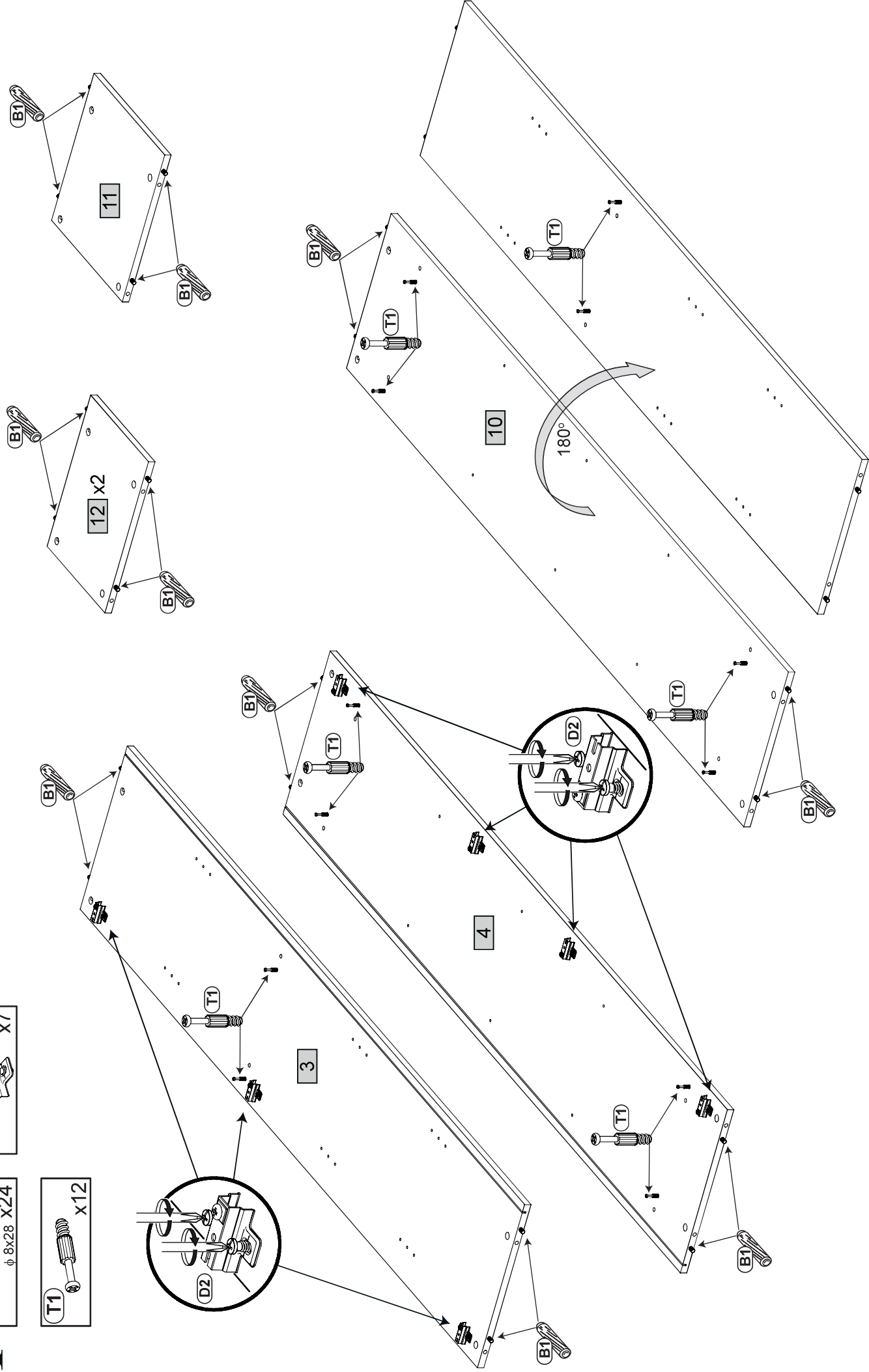
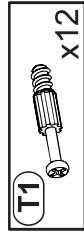
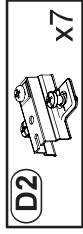

**1**



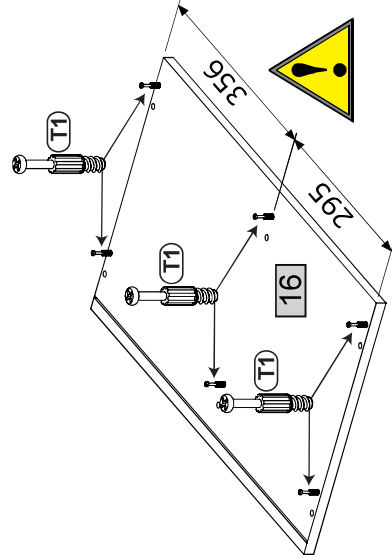
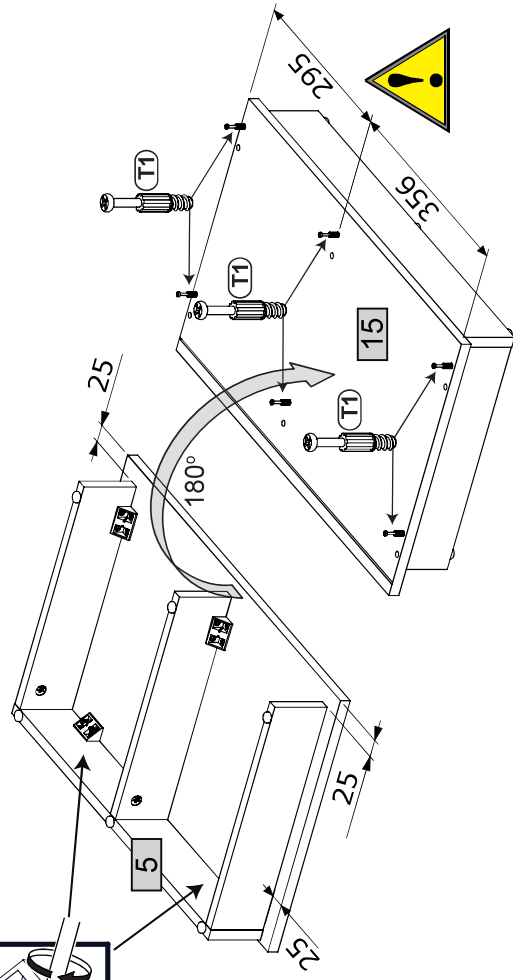
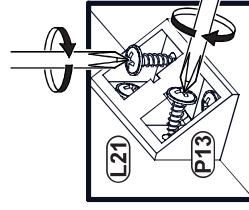
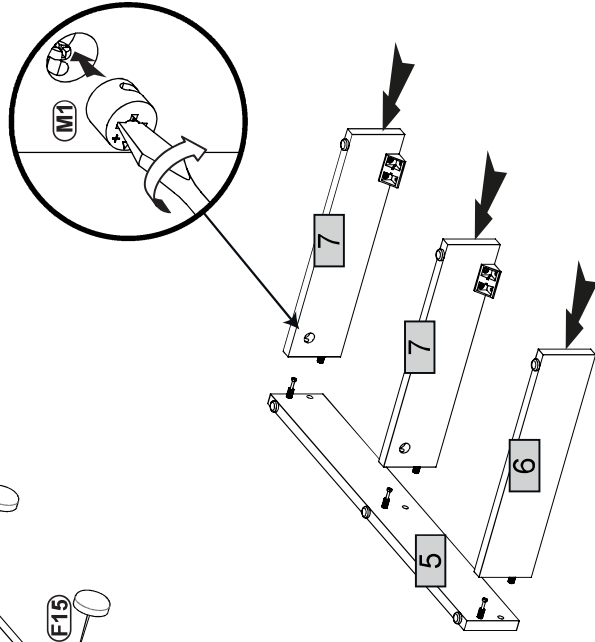
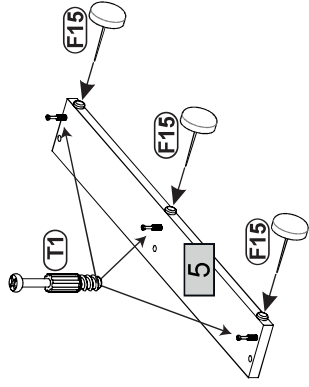
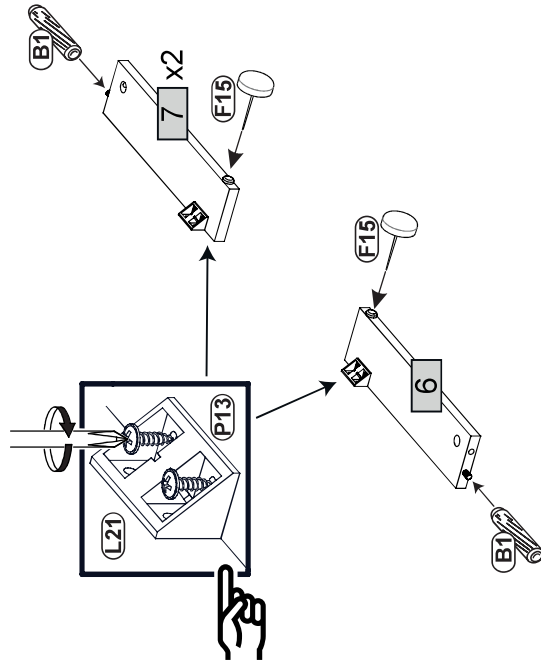
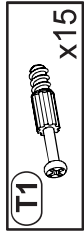
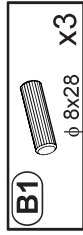

2



3

	X7
	4x16 X14

	X10
	3x16 X10

	$\phi 20$ X12
---	---------------

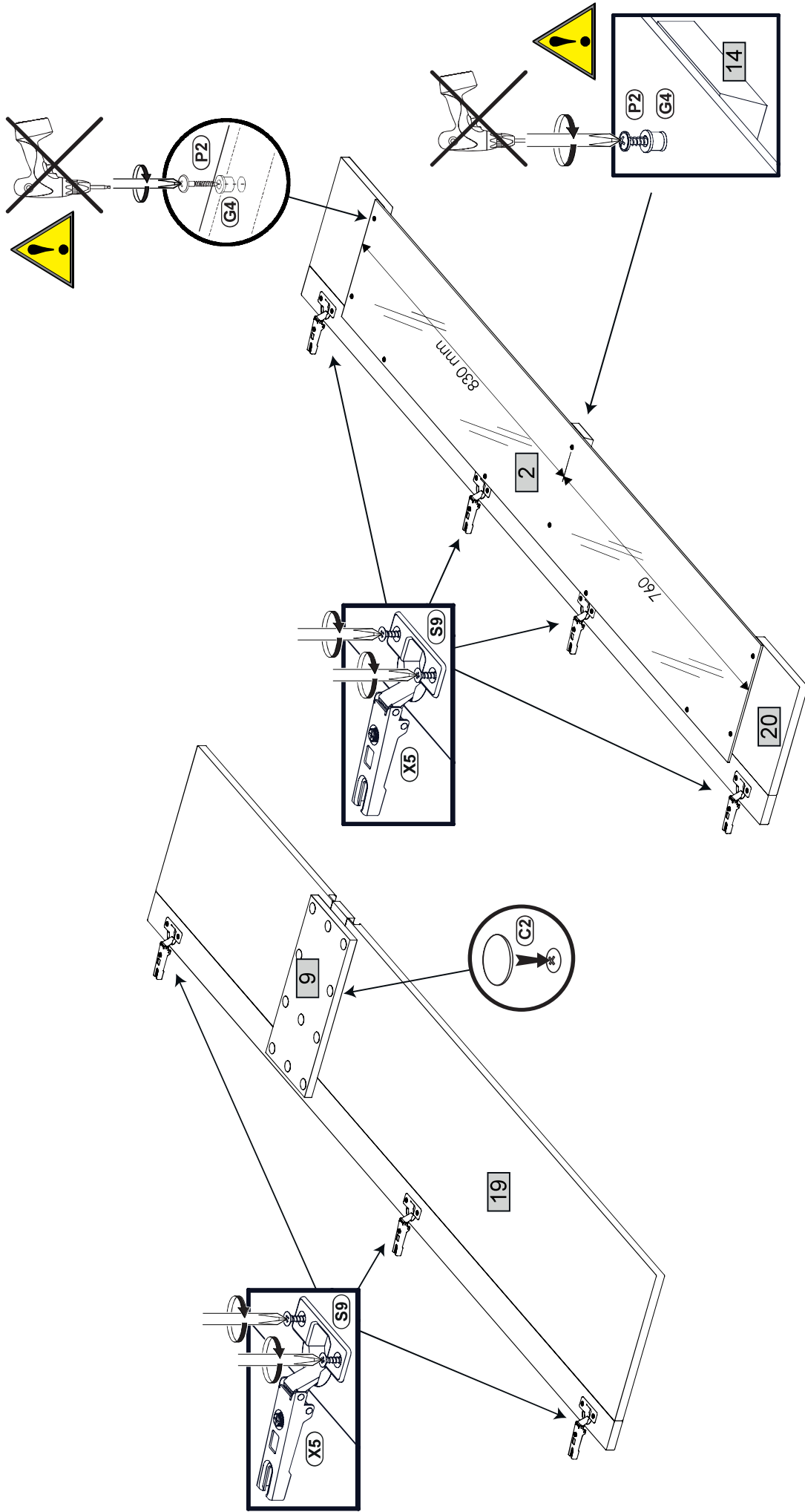

4

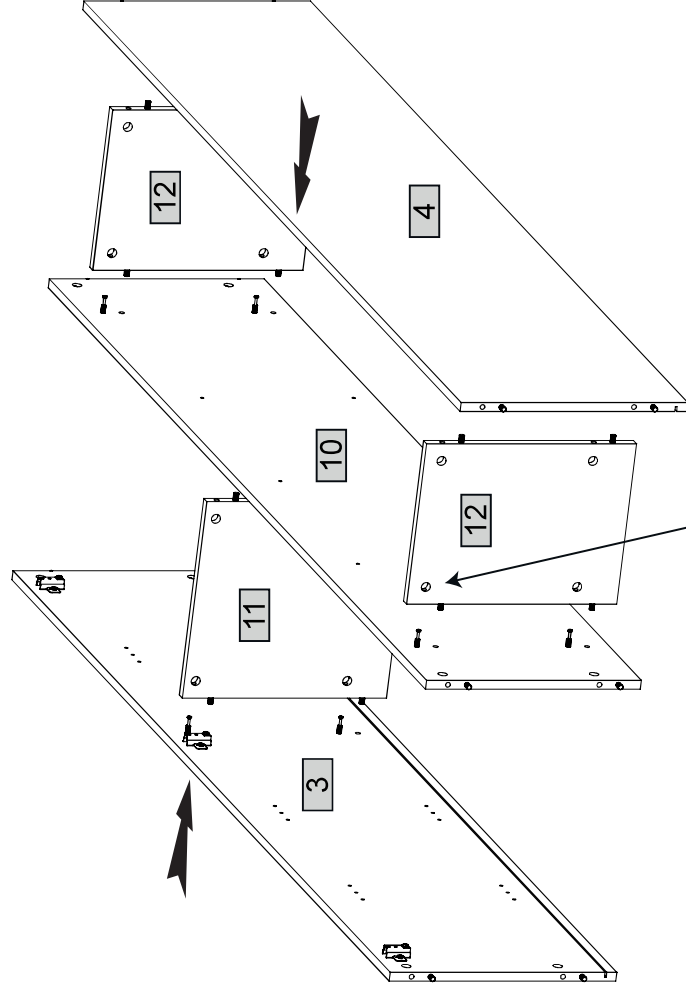

5

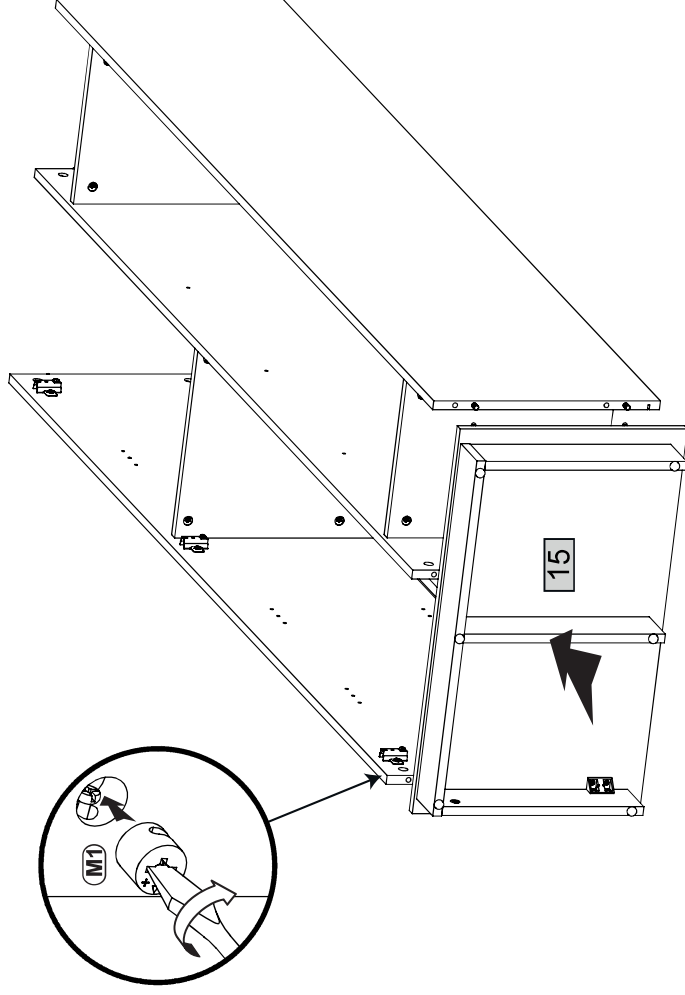

6

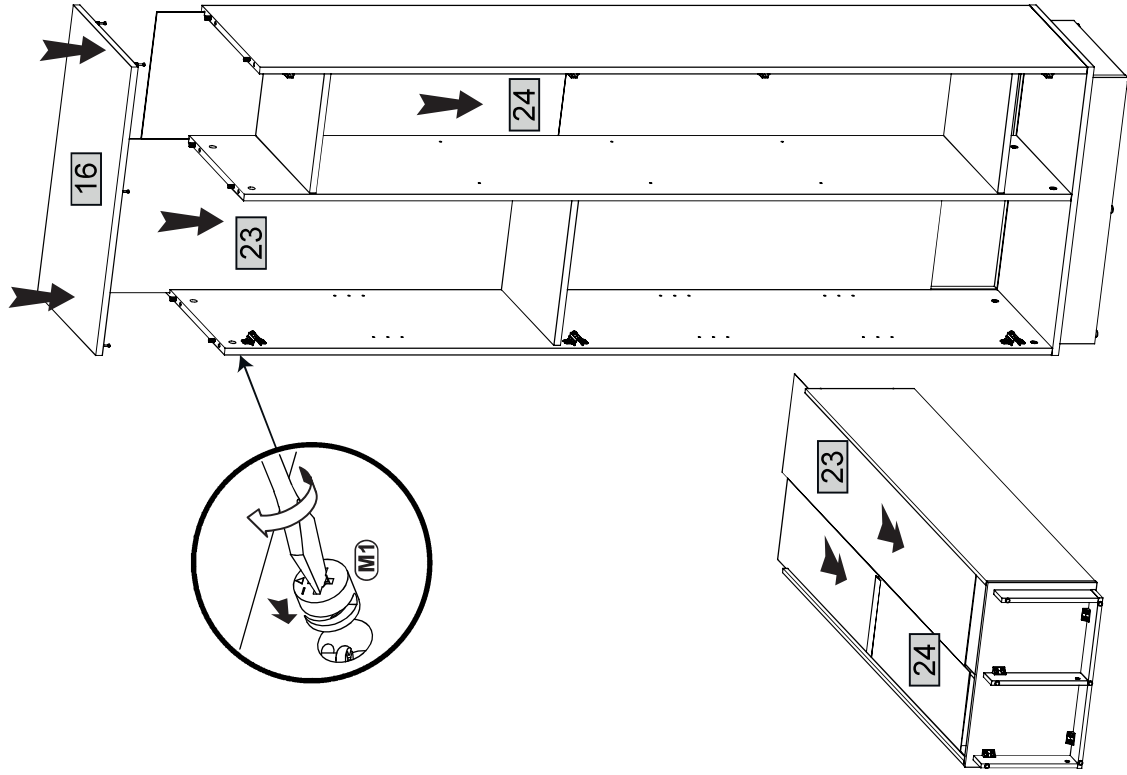

7

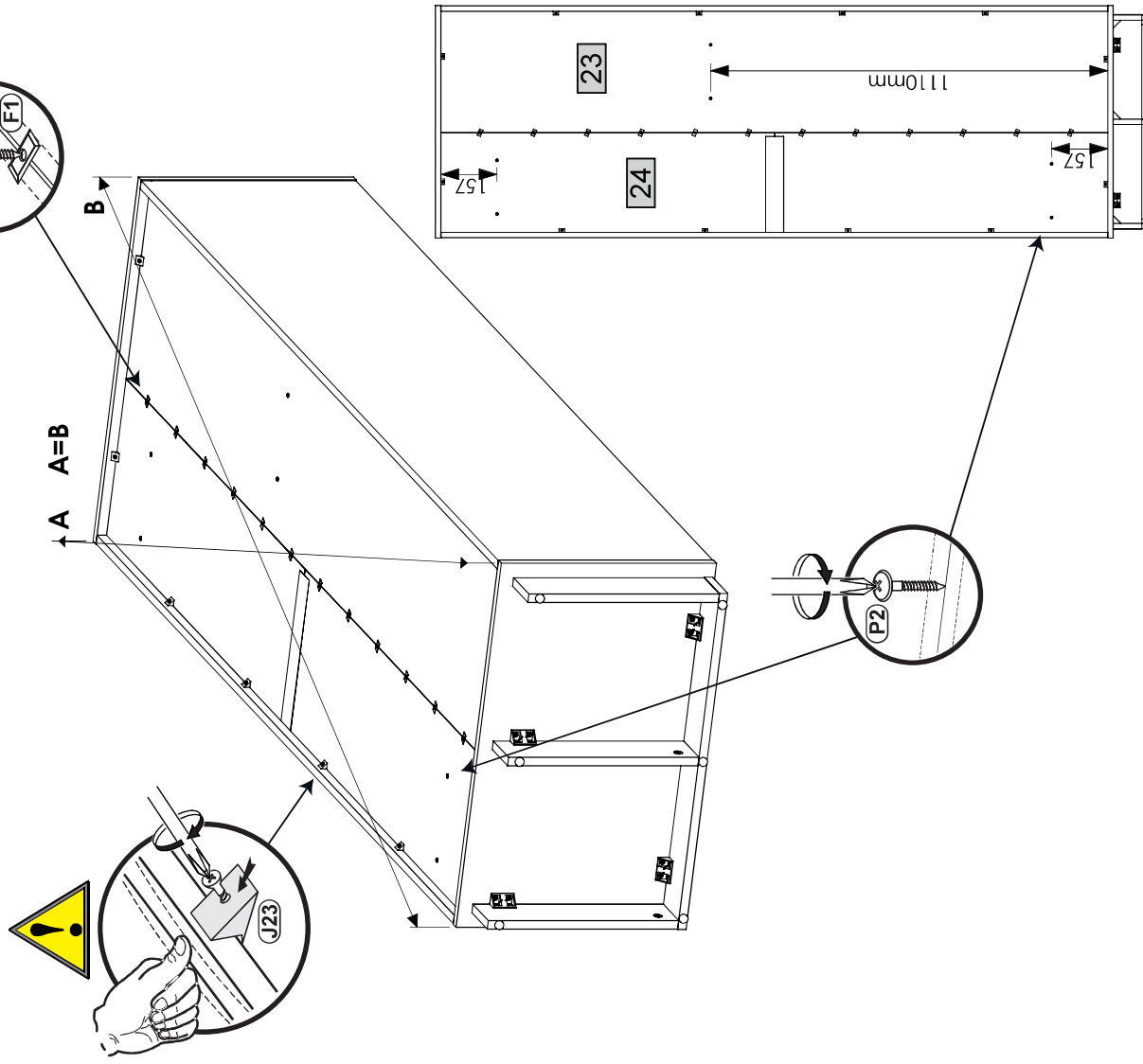

8

- (C2)**  $\phi$  20 x20 x2
- (W1)**  $\phi$  20 x12
- (W2)**  $\phi$  20 x12
- (X19)** x2

- (J11)** x1
  - (P13)** 3.5x13 x2
- 