

Nr	Ausmaß		St	Colli
	480	320		
1	480	320	5	3
2	1590	451	4	1
3	1864	383	15	1
4	1864	383	15	1
5	810	80	15	1
6	340	80	15	1
7	340	80	15	2
9	324	160	15	1
10	1864	363	15	1
11	332	345	15	1
12	481	355	15	2
13	332	345	15	3
14	434	60	15	1
15	860	384	15	1
16	860	384	15	1
19	1890	360	18	1
20	1890	494	18	1
23	1878	346	2	1
24	495	939	2	2

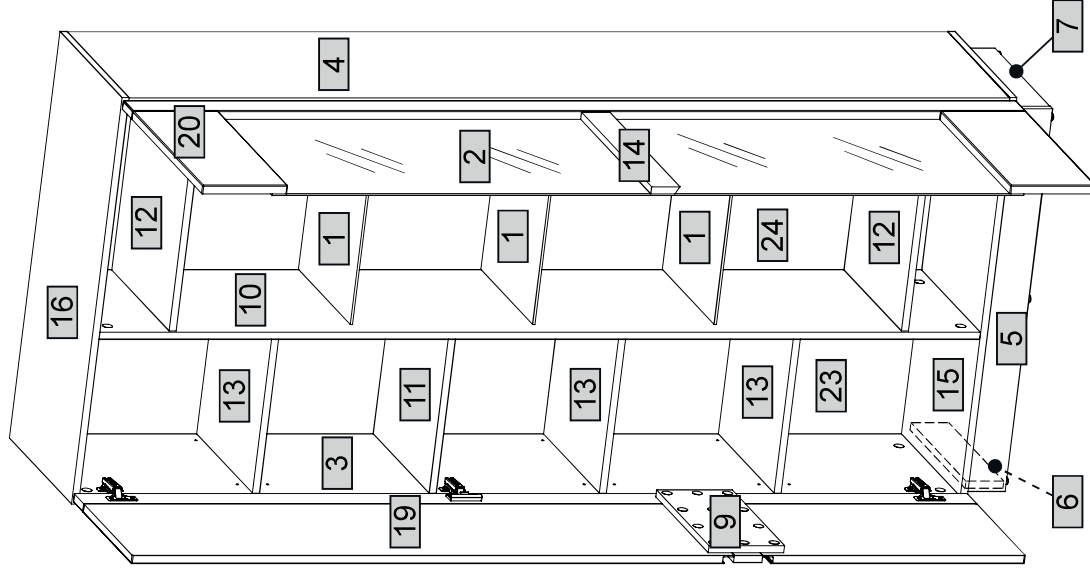

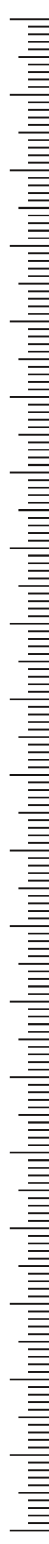

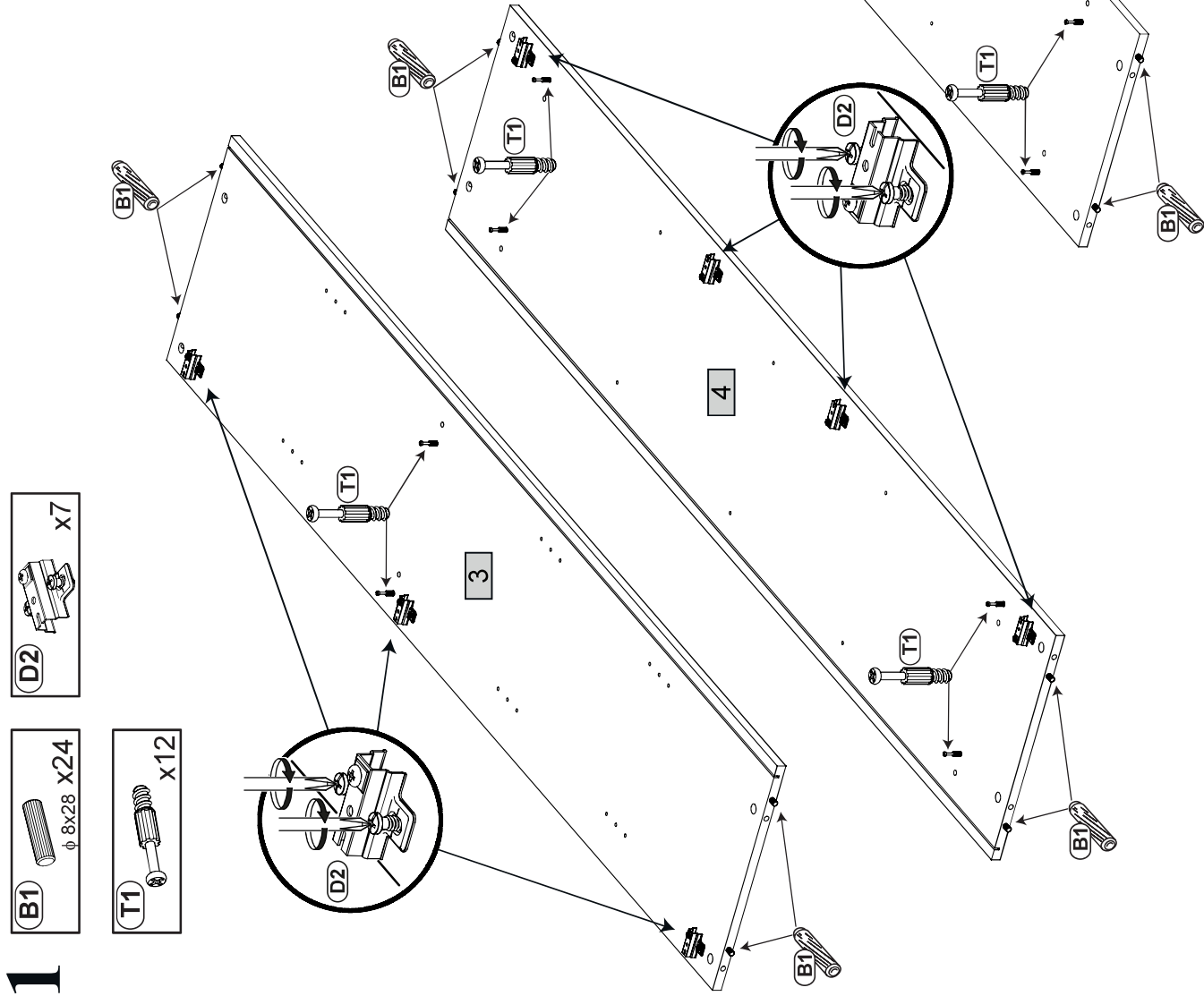
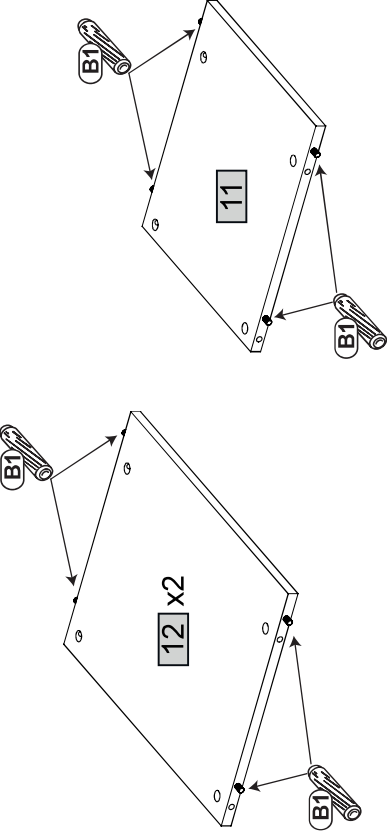

0 10 20 30 40 50 60 70 80 90 100 110 120 130 140 150 160 170 180 190 200





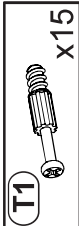

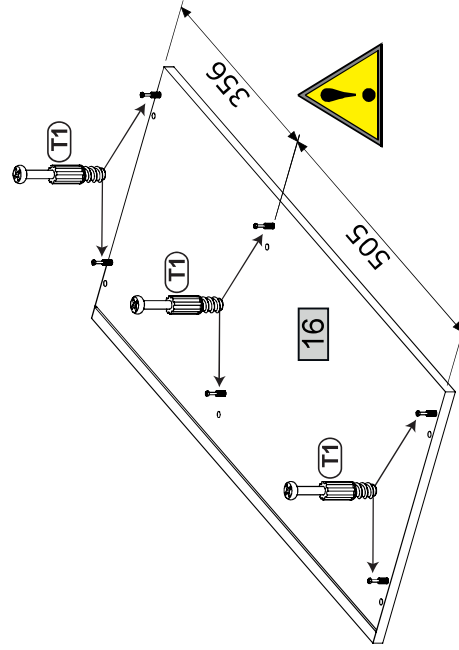
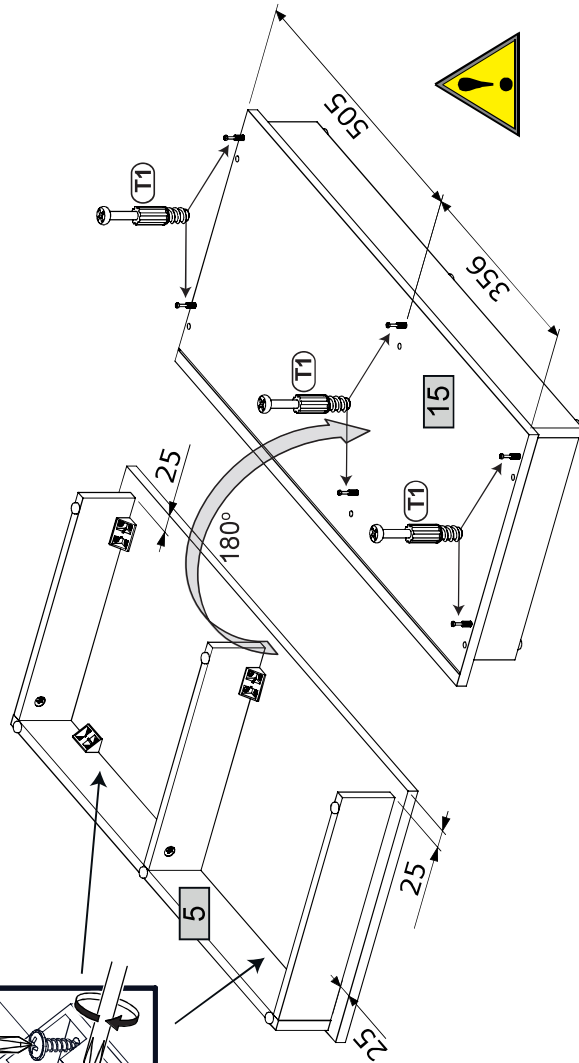
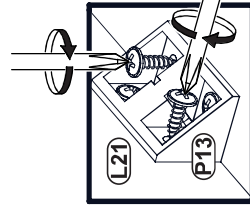
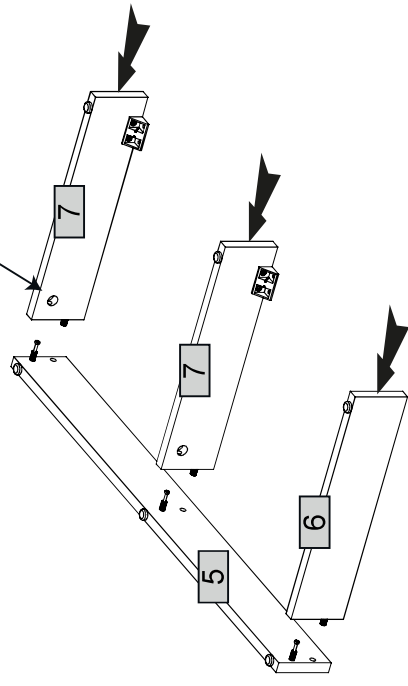
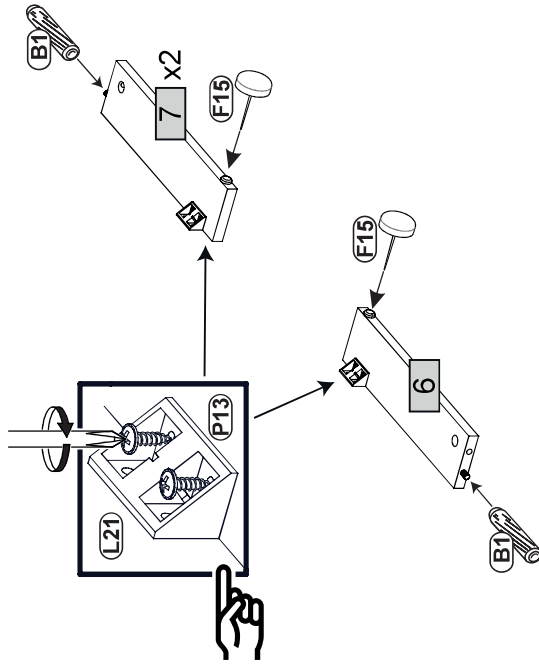
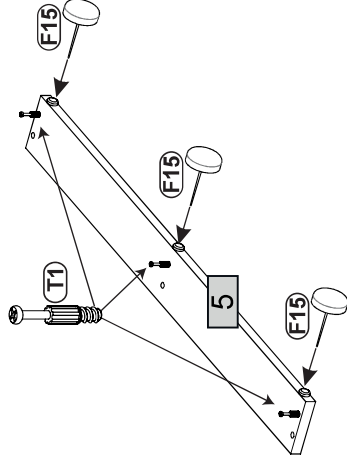

2

- | | | |
|--|---|---|
| (B1)
 | (F15)
 | (L21)
 |
| x3 | x6 | x5 |
| (T1)
 | (M1)
 | (P13)
 |
| x15 | x3 | 3.5x13 x20 |



3

	X7
	4x16 X14

	X13
	3x16 X13

	$\phi 20$ X12
---	---------------

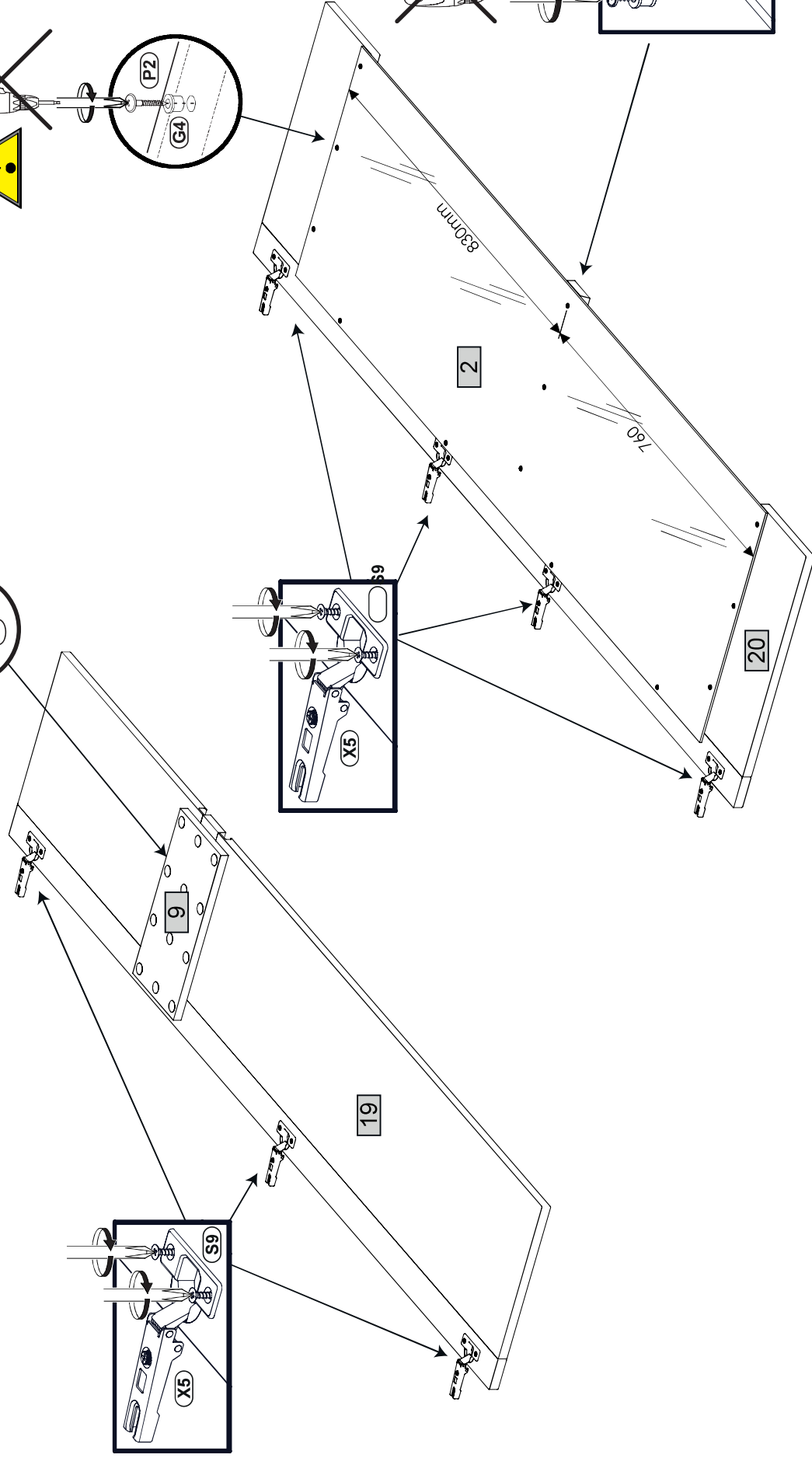
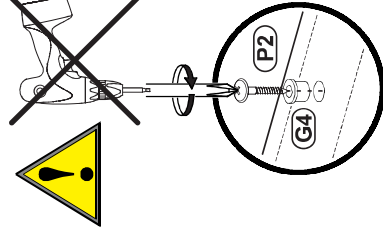
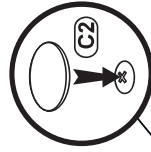

19

2

20

14

830mm

160

4

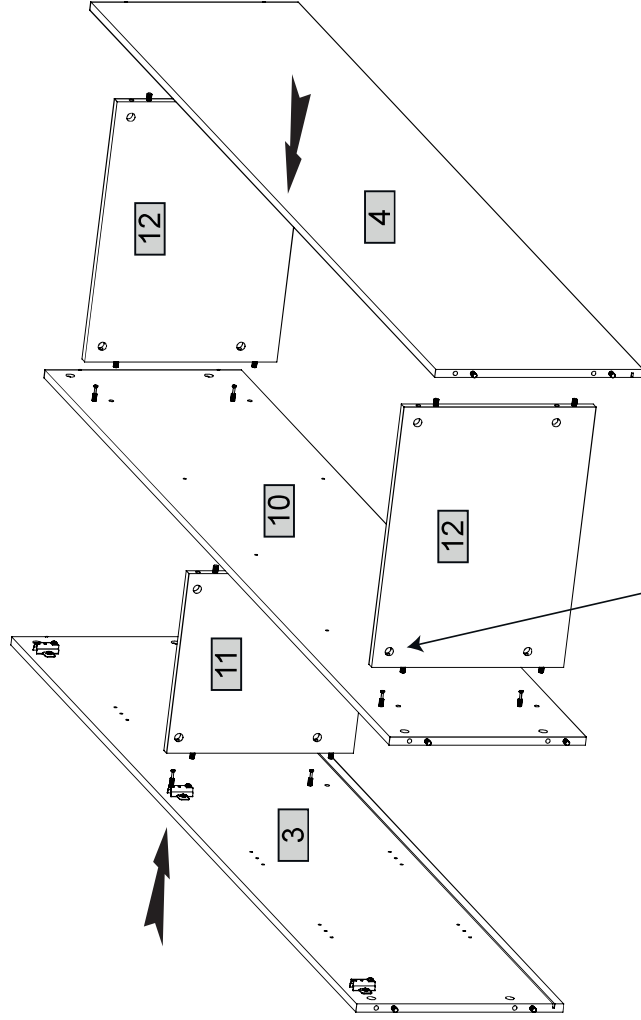

5

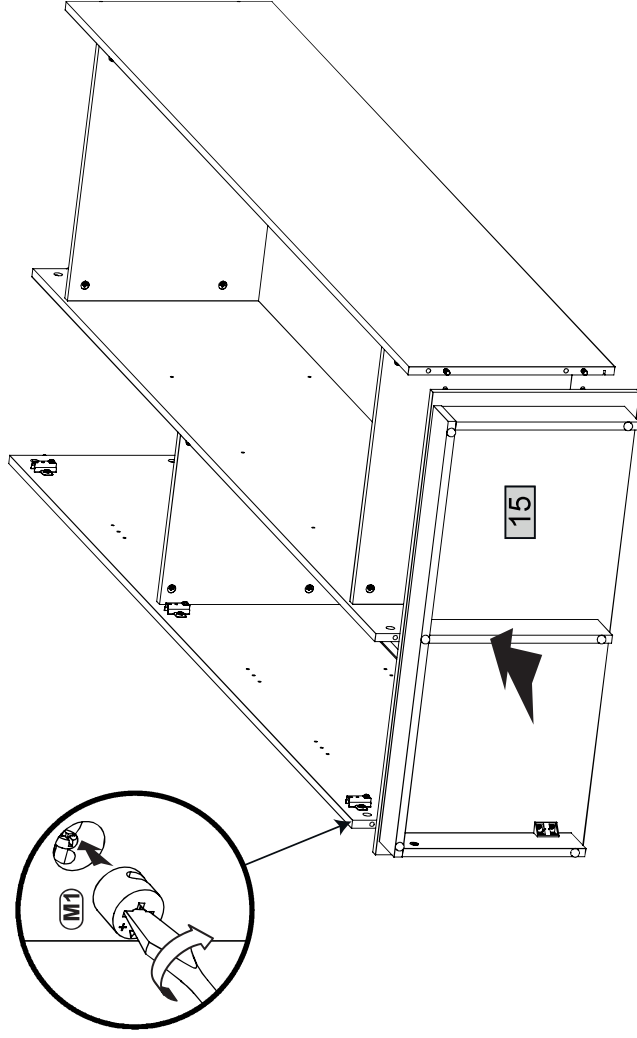

6

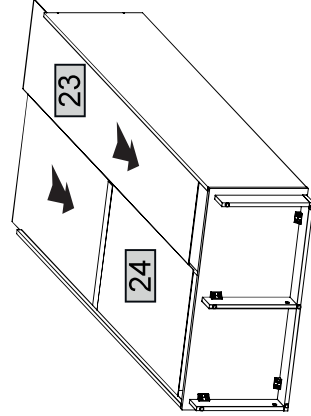
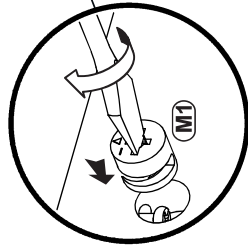
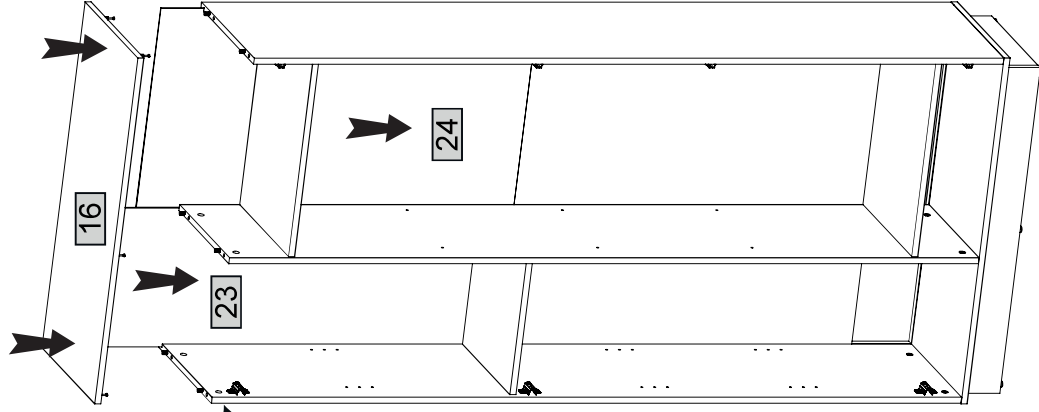

7

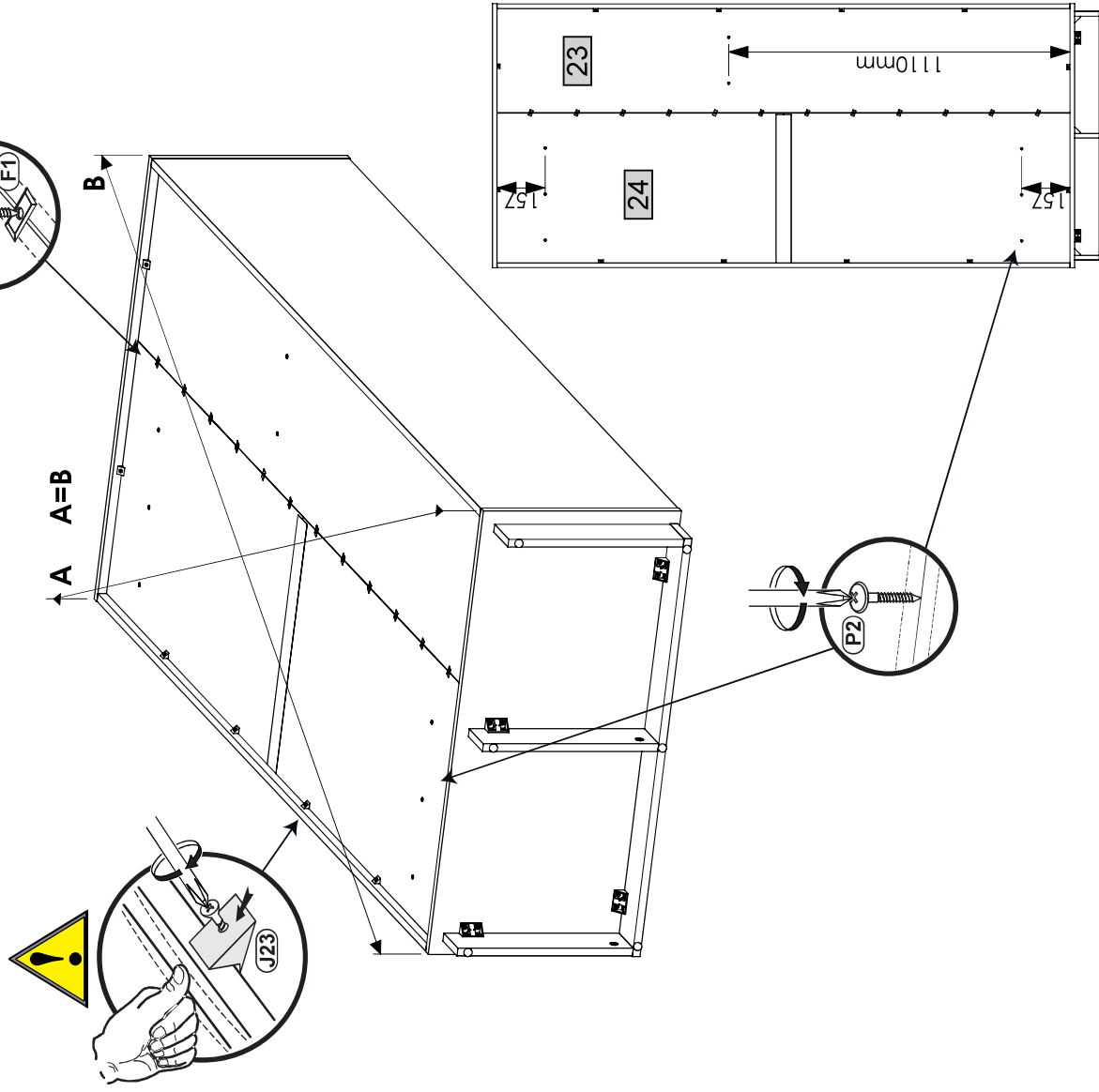

- C2** ϕ 20 x20 x2
- W1** x12
- W2** x12
- X19** x2

- J11** x1
 - P13** 3.5x13 x2
- 